

How to Install a Pair of Courtyard Gates

Thank you for choosing Jacksons Fencing. Our high quality fencing products will last for years and give you trouble-free service if you follow the installation instructions below, which are offered as a general guide.

Tools

Spirit level	Hammer	Spade / showholer
Tape measure	Pencil	Shovel
Adjustable spanner	Rammer	A few marker pegs
Packing pieces	Long straight edge or plank	

Materials

Gate(s)	Hanging Posts	Gate fittings
Ballast	Cement	Holding back catch & posts
Centre Gate Stop		

Notes before we begin

Please note that we do not recommend installing the posts prior to having the gates on site. We also recommend that due to the weight of the gates, that installation should be done with at least two people.

Method

- 1) Clear and level the site. The ground over which a gate will hang and swing must be reasonably level.
- 2) To check ground clearance, use a long plank or straight edge and spirit level. You should drive a peg into the ground adjacent to the approximate position of the hanging posts. These pegs are to accommodate the straight edge, and should be driven in to give a level across the gateway with approximately 50 - 75mm clearance.
- 3) Move the plank round from the hanging post side to various points around the swing of the gate and in the level position, checking the ground clearance. When the spirit level reads level, check the clearance between the bottom of the plank and the ground. If the dimension is the same in each case the ground is level. If the dimension is less the ground is higher; lower if the dimension is more. When you have ascertained the ground levels, you need to decide the best clearance to leave under the gate with the gate in its closed position to allow it to swing through its desired arc.
- 4) Dig holes for the hanging posts to the correct depth for height of gate plus the established required ground clearance. The holes should be a nominal 450mm square, but this may vary depending on softness of the ground. The gate posts should be set at the overall length of gates ordered plus 25mm spacing either end, and 12mm to the centre. A total of 62mm workable clearance. Always check the length of the gate with a tape measure.
(ie - Leaf = $1500 \times 2 = 3000 + 62 = 3062$ between posts)
- 5) Check the height of the gate posts and make sure they are upright with the spirit level. Concrete in using an 8:1 mix of ballast and cement. Gate hinge pins should normally be on the rear of the posts, facing in towards the property. Depending on preference, either:
 - (a) bring concrete mix to the top of the hole and trowel back smooth, allowing for water to run off
 - or
 - (b) leave short of surface by approx 50 - 100mm, and then place soil above.

A quick check that the posts are still upright before the cement sets is advisable.

The posts should be left to set before hanging the gates, as gates have an internal metal frame, and are very heavy. If intending to hang the same day, a rapid hardening cement should be used. Leave the posts to set for at least 3 hours and once gates are hung chock the 'slam' stile of each leaf to support the weight overnight.

The gates purchased from us should be ordered complete with the gate fittings you require (hinges and catch), in order to hang them. Gates are only adapted for automation if this is clearly specified and full automation details provided at the time of ordering.

- 6) Gates can now be lifted into position, bottom hinge eye onto hinge pin (using a Nylon washer), and top eye bolt between the two rides; top hinge secured using M20 bolts and shear nut to hold in position. After making sure the gates swing easily and meet correctly in the middle, tighten up the top pin with the hexagonal shear nut. With a small amount of force, break off the shear nut with a hammer, if it does not shear when tightened up.
- 7) Close the gates, and mark the centre for the position of the centre stump. Dig hole for the centre stump, and concrete in. The raised part of the stump should face away from the direction the gates open. Please note - If a centre stump is not fitted there is increased risk of gate damage in high winds, plus increased risk of gates twisting, none of which would be covered by our guarantee.
- 8) Check gates for levels, and make any minor adjustments that are required. Add the slamming strip to the slam side of the gates, to fill the void between the gate and post. Adjustments can be made by loosening the inner nut and tightening the outer nut to lift on the top hinge lug. The gate should be supported at the leading edge when doing this.
- 9) For manual gates add side Shutting Strips, drop bolts and latch. Automated gates will normally require finger guard strips to be fitted and should not have shutting strips, drop bolts or latch.

If the automation is planned but not being carried out immediately, block the gate in position, so it cannot be blown about by winds.

Maintenance

Provided the gate has been installed correctly, it should not give you any problems, but if it drops over a period of time, adjustments can be made.

If gates are installed for manual operation, but are to be automated later, please be aware that fixing holes will be visible when manual fittings are required.

Safety Notes:

Biocidal Products Regulation (EU528/2012):

Jakcured articles incorporate biocidal products to protect against wood destroying organisms.

Active ingredients include: Copper(II)Carbonate / Copper(II)Hydroxide / Propiconazole / Tebuconazole

Wear gloves when handling freshly treated wood. Avoid breathing dust when cutting. Dispose of off-cuts responsibly – do not burn.

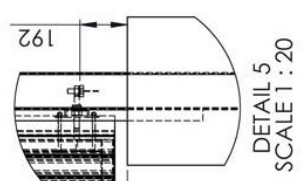
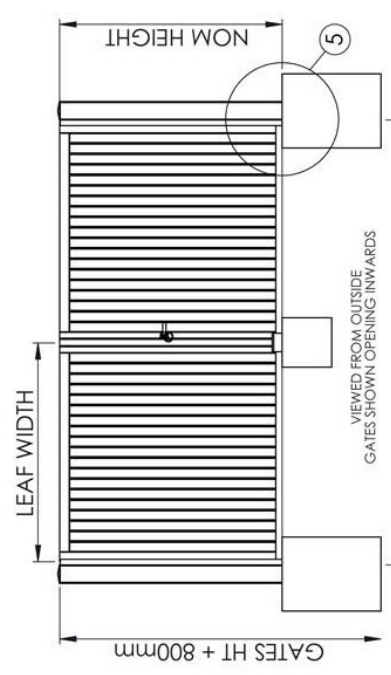

POSTS SHOULD BE SET INTO FOUNDATIONS SO THEY THE UPPER FACE OF THE LOWER HINGE LUG IS 192mm (approx) ABOVE GROUND. THIS SHOULD BE THE HIGHEST GROUND LEVEL IF INSTALLING ON AN UNEVEN SURFACE.

NOTE SHUTTING STRIPS SUPPLIED LONGER THAN GATE HEIGHT FOR SETTING IN CONCRETE AS AND IF REQUIRED.

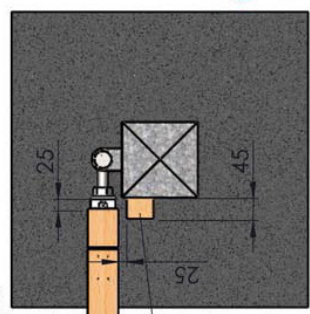

FIT SHUTTING STRIP TO HANG POST USING SELF DRILLING/TAPPING SCREWS TO HIDE ADJUSTMENT GAP.

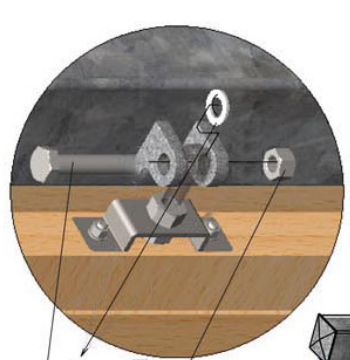

HEX BOLT
NYLON WASHER
SHEAR NUT, SNAP OFF WHEN TIGHTENED



CLOSING STRIP

DETAIL 4
SCALE 1 : 10

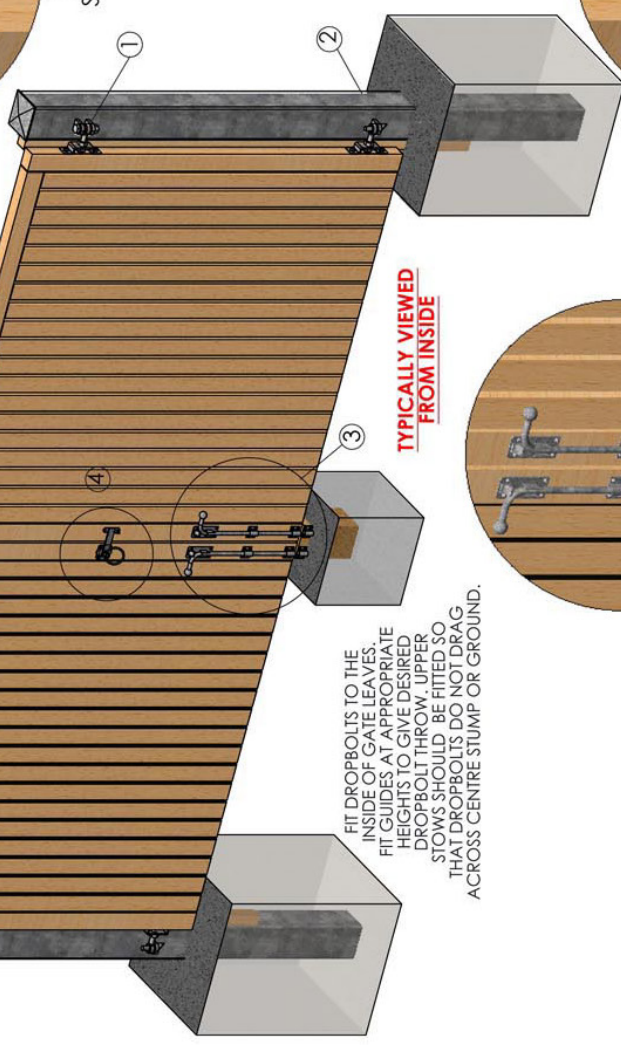

TYPICALLY VIEWED FROM INSIDE

FIT DROPBOLTS TO THE INSIDE OF GATE LEAVES. FIT GUIDES AT APPROPRIATE HEIGHTS TO GIVE DESIRED DROPBOLT THROW. UPPER STOWS SHOULD BE FITTED SO THAT DROPBOLTS DO NOT DRAG ACROSS CENTRE STUMP OR GROUND.

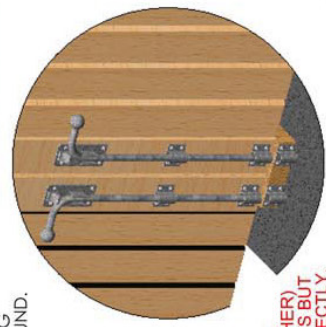

DETAIL 3
SCALE 1 : 10

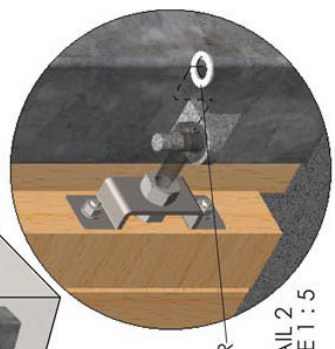

NYLON WASHER
DETAIL 2
SCALE 1 : 5

IMPORTANT!
JACKSONS COURTYARD GATES ARE DESIGNED TO BE HUNG FROM THE REAR OF THE GATE POSTS TO OPEN INWARDS AND THE FRONT IF OPENING OUTWARDS. HANGING 'BETWEEN' THE POSTS (HINGES FACING EACH OTHER) WILL RESULT IN UNSIGHTLY GAPS BETWEEN LEAVES AND POSTS BUT COULD ALSO RESULT IN GATES NOT FITTING OR CLOSING CORRECTLY IF YOU ARE AT ALL UNSURE CONTACT JACKSONS FENCING BEFORE ATTEMPTING TO INSTALL YOUR GATES. THE GATES ILLUSTRATED ARE 'MANUAL'. IF YOU PLAN AUTOMATING LATER PLEASE ASK FOR ADVICE ABOUT RECOMMENDED SAFETY REQUIREMENTS AS THE INSTALLATION REQUIREMENTS MAY BE DIFFERENT.

Internal Reference No J7/02/198