

DO NOT SCALE – IF IN DOUBT ASK

Quantity

SINGLE PERGOLA RAIL

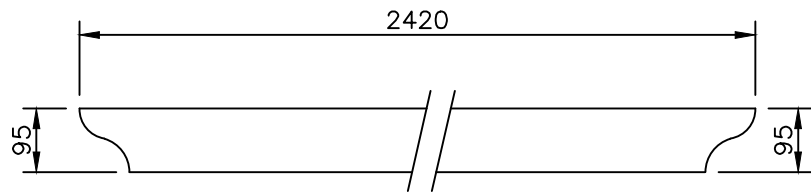

Quantity

PERGOLA END RAIL

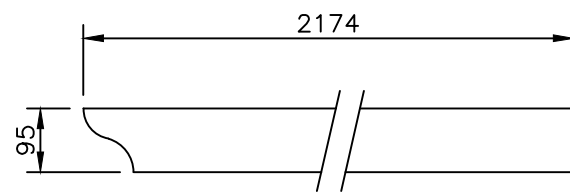

Quantity

PERGOLA INTERMEDIATE RAIL

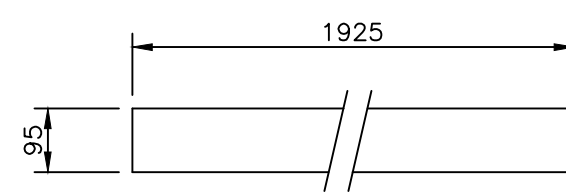

Quantity

SPACER BLOCK
(95x95x35)

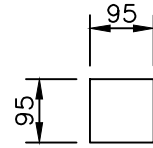

Quantity

SHORT CROSS MEMBERS

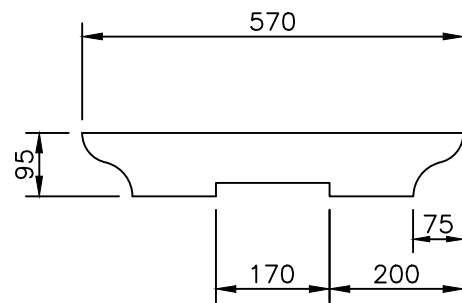

Quantity

IN LINE BRACE
(91x91x500)

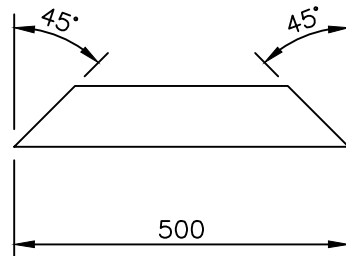

Quantity

CORNER BRACE
(95x35x590)

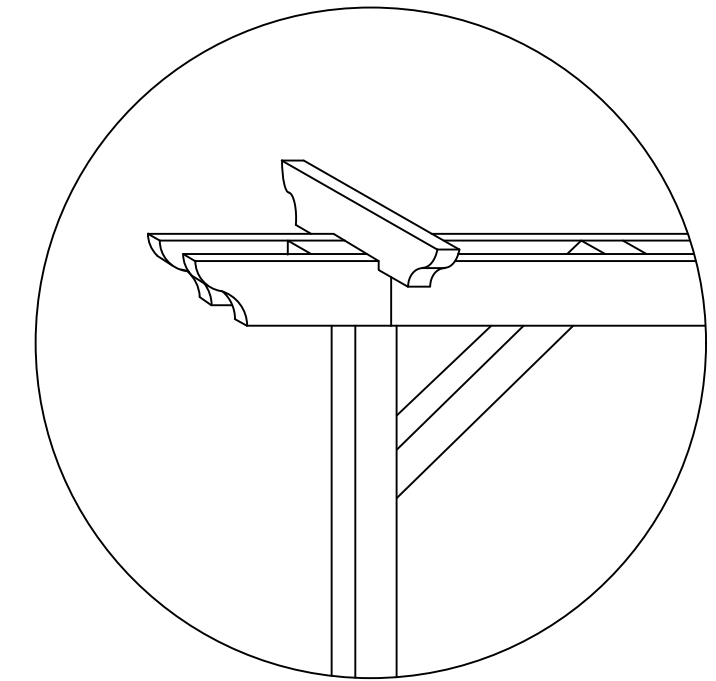
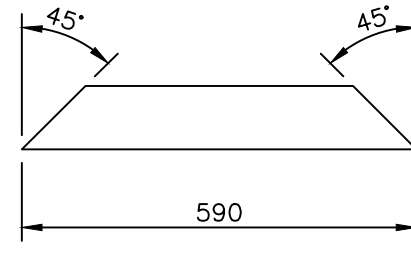

**Jacksons
Fencing**

Stowting Common, Near Ashford,
Kent. TN25 6BN
Telephone: 01233 750393
Fax: 01233 750403
www.jacksons-fencing.co.uk
www.jacksons-security.co.uk

- ② 04/01/19
- ① 17/09/10
- ① 07/01/05

MISSING COMPONENTS ADDED
Cross Member On Other Sheet
Original Issue

Drawn Liam

Date 07/01/05

Checked

Size
A3

Scale n/a
U.O.S

TITLE

Pergola Components

CUSTOMER

ACK No.

Drawing No.

06 J7/01037

Sheet 1