

Jacksons Fencing

CRAFTED FOR LIFE MADE WITH PASSION



The Good Fencing Guide

www.jacksons-fencing.co.uk

CRAFTED FOR LIFE **MADE WITH PASSION**

From humble beginnings serving the agricultural communities in East Kent with fencing stakes, to recognition as one of Britain's top 200 privately owned companies in terms of growth in international sales; you can be sure that every Jacksons fence, gate and garden structure carries with it a hard-won reputation for quality and durability spanning over seventy years.

Look closer and you'll also find more tangible clues to Jacksons quality, including the use of carefully selected sustainable timber, traditional craft joints, stainless steel screws, heavily galvanised fixings and our Jakcure® timber treatment, a process that goes well beyond skin deep; all of which gives us the confidence to offer a 25 year guarantee against rot and insect attack on our timber manufactured products.

A Jacksons product is unlikely to be the cheapest you'll find, but quality is remembered long after the price is forgotten. That's never truer than when you compare a lesser quality fence or gate that you might have to replace up to four times before a Jacksons Fencing product reaches the end of its useful life.

But what makes a Jacksons product different is the 280 people working together to design and manufacture products that provide safety, security, and sustainability; products which will not only perform their function but also enrich the lives of our customers and respect the environment.

It's a founding principle of the business started by my father and grandfather in 1947 and one that we all remain passionately fixated on.

Peter Jackson



General Information

The Jakcure® Treatment Process	4 - 7
Jacksons Service	
More Reasons to Choose Jacksons Fencing	

Garden Panels and Fencing



Featherboard Panels:	
Level Top, Concave and Convex	8 - 9
Tongue & Groove Effect Panels:	
Level Top and Convex	10 - 11
Horizontal Tongue and Groove Panels	12 - 13
Railing Topper Panels:	
Level Top, Concave and Convex Panels	14 - 15
Hit & Miss Horizontal & Vertical Panels	16 - 17
Louvre Panels	18 - 19
Venetian Panels	20 - 21
Venetian Hit & Miss Panels	22 - 23
Aran Panels	24 - 25
Mitre Panels	26 - 27
Metro Panels	28 - 29
Chilham Panels	30 - 31
Woven Panels	32 - 33
Canterbury Combi Panels	34 - 35
Urban Panels	36 - 37
Shadowline Panels	38 - 39
Jaktop Panels	40 - 41
Palisade Panels	42 - 43
Traditional Palisade/Picket	44 - 45
Traditional Closeboard / Featherboard	46 - 47
Posts: Slotted Jakposts, Standard and Square	48 - 49
Mi-T Metal Garden Fence Posts & Post Foot	50 - 51
Gravel Boards including Hedgehog Friendly	52 - 53
Post caps, Finials and Capping	54 - 55
Jakoustic® Acoustic Barriers	56 - 59
Metal Railings - Barbican® & Sentry Residential	60 - 61
Bow Top Metal Fencing & Playtime® Timber Panels	62 - 63
EuroGuard® Regular Welded Wire	
& EuroGuard® Combi	64 - 65

Garden Gates



Featherboard Gates:	
Level Top, Concave, Convex	66 - 67
Brook & Brabourne Gates	68
Hit & Miss Gates	69
Venetian Gates	70
Chilham Gates	71
Woven Gates	71
Canterbury Combi Gates	71
Jaktop Gates	72
Palisade Gates	72
Square Standard Trellis Gates	73
Premier Trellis Gates	73

Trellis, Decking & Shelters



Pergolas	74 - 77
Premier Trellis Range	78 - 79
Standard Trellis & Metal Trellis	80 - 81
Tartan Trellis	82 - 83
Jakwall® Landscape Timbers & Sleepers	84 - 85
Decking and Balustrade	86 - 89
Jak-Deck Kits	90
Decking Calculator	91
Fencing Calculator	91
Venetian Retreat	92 - 93
Woven Retreat	94 - 95
Wheelie Bin Store	96 - 97
Sissinghurst Planters	98 - 99

Gates - Entrance, Drive, Courtyard & Automation



Courtyard Gates	100 - 101
Railing Panel & Cathedral Courtyard Gate	102 - 103
Timber Sliding Gates	104 - 105
Ornamental Gates: Arched Top, Level Top	106 - 107
Residential Auto-Gates	108 - 109
Access Control Options	110 - 111
Entrance Gates for the Drive or Field	112 - 113
Uni Gates for the Drive or Field	114 - 115
Gate Fittings, Accessories, Posts and Latches	116 - 117

Agricultural, Equestrian & Demarcation



Metal Field Gates	118 - 119
Estate Railing Fencing	120 - 121
Post & Rail Special Heavy Morticed	122 - 123
Post & Rail Nailed Sawn / Square or Half Round	124 - 125
Post & Rail Morticed	126 - 127
Chain Mesh Fencing	128
Fencing Stakes & Posts	129
Wire Fencing & Netting	130 - 131
Tree and Netting Stakes	131
Cleft Chestnut Fencing	132 - 133
Kissing Gates Timber and Steel RADAR Padlock	134
Kissing Gates Metal	135
Stile with Dog Gate, R.O.W. Latch and Bridle Gates	136
Demarcation Fencing & Devices and Landscape Timbers	137
Timber Bollards	138
Metal Bollards	139
Verge Protection Posts, Steel Hoops & Barriers	140 - 141

Security, Chain Link & Miscellaneous



Cobra-Spike® Security Topping and Security Comb	142
Barbed Tape	142
Rota-Spike® and Viper-Spike Security Topping	143
Razor Wire	143
Anti-climb Express Temporary Fencing	144
Tubular Fencing System	145 - 149
Tubular System Gates	150 - 151
Chain Link Cladding Galvanised and Galvanised & PVC Coatings	152 - 153
Welded Mesh: Heavy and Light	153
Tubular Tennis Court Surrounds	153
Chain Link Accessories	154
Fixing Tools and Miscellaneous	154 - 158

How To Find Us And Other Information

Jacksons Index	159
Our 25 year Guarantee: Qualification and Limitations	
Timber Treatment Service & Jacksons Service	160
How To Find Us and Contact Details For Jacksons	
Ashford, Bath and Chester Fencing Centres & Delivery	161

For additional information on all of these products please view our website:

www.jacksons-fencing.co.uk

Call 0800 41 43 43 or Buy Online: www.jacksons-fencing.co.uk

The 25 year Jakcure® Guarantee

Jakcure® treated timber is guaranteed for 25 years from the date of purchase and installation in line with our installation documents where available (see website for details) against failure as a result of rot or insect attack which renders the timber unfit for purpose. Any Jakcure® treated product, unless specifically excluded, so damaged within 25 years of purchase will be replaced free of charge.



How the Jakcure® process works

First, all softwood is tested for moisture content - because excess moisture prevents absorption of the preservative. All timber with more than 30% moisture content is kiln dried. This drying process is essential to ensure deep penetration into the wood fibres. The preservative is forced by vacuum/pressure right through the outside sap wood to the heartwood, where it forms an insoluble compound giving permanent protection against rot and insect attack.

The greater the loading of preservative, the greater the protection and a guaranteed longer life

Our unique Jakcure® process gives us the confidence to back our treated timber products with a 25-year guarantee. Gloves should be worn when handling freshly Jakcure® timber, but once installed it is harmless to man, animal and plant life. Jakcure® treated products have no unpleasant odour and the process does not make timber brittle or reduce its strength. Jakcure® exceeds the requirements of BS EN 599-1 and BS 8417 and provides lasting protection, above and below ground, against all wood-boring pests and all forms of wet and dry rot.



The Lowest Lifetime Cost

The Jakcure® treatment process adds 15% to our costs, so Jacksons fencing and gates will cost you marginally more than lesser products, but it will last many times longer, so when you use Jacksons Jakcure® treated timber products, you can be sure that they are guaranteed for 25 years without the need for further treatment, which means you only need to buy and erect them once. That's real economy and really good for the environment too.

Please refer to our simple list of conditions relating to our guarantee and installation instructions (can be found at: www.jacksons-fencing.co.uk/installation-instructions) or recommendations and also read our Jakcure® T&Cs on p.158.

See the difference - the effect of timber drying on the treatment penetration

Eight timber posts of the same species are selected as samples. Timber is a natural material and takes up water as it grows. So, when it arrives with us from the sawmill it will be very wet, sometimes with a moisture content in excess of 100% of the weight of the dry wood.



Sample 'A'

Sample 'B'

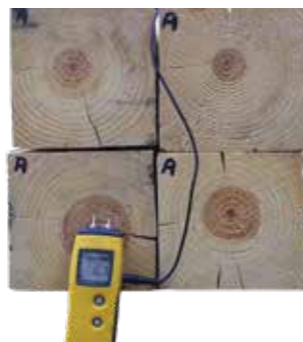

Sample 'A' is then kiln dried to well below 28% moisture content



Sample 'B' is left as it is

Both samples 'A' and 'B' are vacuum pressure treated identically

After treatment, samples 'A' and 'B' are cross cut at more than 300mm from the ends to reveal the actual penetration of preservative achieved. You should note that while both samples look the same superficially, the penetration level of preservative into sample 'A' extends to the heartwood a huge difference to that achieved in sample 'B'. And it's this difference that dictates whether a fence or gate will last for 5 years or 25 years, and if any guarantee offered on an inferior product is worth the paper it's written on.



Sample 'A' close up



Sample 'A'



Sample 'B'



Sample 'B' close up





Gate Safe: Setting the Standard for Safe Automated Gates

Gate Safe is the charity set up in 2010 with the support of Jacksons Fencing following the tragic deaths of two children in separate automated gate accidents. It has launched an official IOSH (Institution Occupational Safety and Health) accredited Gate Safe Aware Training course and only installers who have successfully completed the course are eligible to use the Gate Safe Aware Installer logo. Jacksons Fencing is a Gate Safe 'Premier Installer'.

The Door and Hardware Federation

Jacksons Fencing is a member of The Door and Hardware Federation, a long-established trade association that helps its members comply with the latest CE marking legislation and health and safety compliance legislation. They work closely with installers of powered gates to raise awareness of the need for an enhanced understanding of automated gate safety. With the ultimate aim of maintaining and raising quality standards throughout the industry, all DHF members must meet Quality Assured standards of competence and customer service. They all operate within a code of conduct governing standards of workmanship, quality, training, safety, business integrity and CE marking compliance.

Secured by Design and LPS 1175

Jacksons Fencing is a Secured by Design Licensed Company with products which meet technical standards endorsed by endorsed by the UK Police Service. In addition, we have the UK's widest range of security rated fencing, tested and certified by the Loss Prevention Certification Board.

Jacksons Service: Exceptional Fencing, Gates and Garden Structures Backed by Unrivalled Service

Jacksons Fencing is a family run business that was started by Ian Jackson and his father in 1947 which today employs over 280 people in the UK.

Peter Jackson, Ian's youngest son, is the Chief Executive. He is passionate about continuing the Jacksons commitment to providing the ultimate in quality, service and value. This commitment is shared by the whole Jacksons team who take care and pride in what they do - it's a Jacksons Fencing tradition.

Over the years we have built up a sales and advisory team to be proud of. They are on hand to take your initial enquiry and help you with any further information or advice you might need throughout your purchasing journey with us.

In addition to the Head Office in Ashford (Kent) we have two other Fencing Centres, one near Bath and the other near Chester. We also have experienced Fencing Managers covering the country and we can offer a nationwide installation service through our network of Approved Installers. Depending on the nature and location of your project, we will either send you a budget quotation from our Ashford office or hand your

details over to a regional Fencing Centre. If a site survey is required, one of our Fencing Managers or Approved Installers will contact you to discuss your project and arrange to visit you.

Installation services - even the finest fences can only be as secure as their installation - so why take chances?

Jacksons offer you a nationwide service that you can absolutely rely on. Our Approved Installers have all been carefully selected and are highly experienced professionals who will do the job competitively and without skimping - and get it right.

Please call 0800 41 43 43 with your initial enquiry and we will arrange for one of our Approved Installers to contact you to give you a no obligation quotation.

More Reasons to Choose Jacksons

Jacksons Fencing has a third party audited Due Diligence System in place to ensure all of its timber products are sourced from verified legal timber sources and hence conform to the UKTR (UK Timber Regulation) and EUTR (European Timber Regulation) requirements. Jacksons has also achieved certification under the environmental chain-of-custody schemes of both the FSC® (Forest Stewardship Council®) and the PEFC™ (Programme for the Endorsement of Forest Certification™). The majority of our timber product range can be offered certified under one of these two schemes. The environmental chain-of-custody which is monitored from forest source, to primary producer sawmills, through to Jacksons, allows us to ensure that all timber used in certified Jacksons products has been sourced from well managed forests and other controlled sources. Please ask the Sales Team for FSC® or PEFC™ certified products.

Quality Management System

Jacksons Fencing has a certified Quality Management System that complies with the requirements of ISO 9001 for the design, manufacture, supply and control of installation of timber and steel fencing, gates and security barriers to commercial, trade and domestic customers.

Featherboard Panels

One of the strongest types of fencing available, Featherboard fence panels have a traditional Closeboard or Featheredge design, improved by the use of Jakcure® pressure treated timber, and stainless steel fixings. These versatile panels are a timeless feature in any garden.



Panels shown with optional capping rails.



Non-standard gate. Top rail + bottom flush. Normally set 125mm down/up.

Featherboard panels are constructed with 2 rails up to 1.35m high, and 3 rails for 1.5m and above, and clad with 100mm pales to provide one of the strongest close board panel fences available. Featherboard panels are available with Level, Concave or Convex Top options.



Featherboard panels are designed for use with our slotted Jakposts, see pages 48 - 49, and manufactured from superior quality Jakcure® treated softwood, guaranteed for 25 years.

Featherboard panels are 1.83m wide and available in a range of heights, detailed below. Panels may be cut to a desired width on site. It is also available in Kit Form, referred to as Traditional Featherboard System, see pages 46 - 47. For matching gates please see page 66. Stainless steel fixings are used throughout for longer life.

To meet the conditions of the 25 year Jakcure® guarantee, gravel boards are required where panels are in contact with the ground.

Featherboard Panels (1.83m wide)

Level Top			Concave		
Height	Ref	Price	Height* at highest point	Ref	
0.60m	636900 ■			-	
0.90m	637000 ●		-	-	
1.05m	636100 ●		1.05m	635000 ○	
1.20m	637100 ●		1.20m	636000 ○	
1.35m	636200 ●		1.35m	635100 ○	
1.50m	637200 ●		1.50m	636400 ○	
1.65m	636300 ●		1.65m	635200 ○	
1.80m	637300 ●		1.80m	636600 ○	

Convex	
Height* at highest point	Ref
1.05m (0.90m at sides)	635300 ○
1.20m (1.05m at sides)	636700 ○
1.35m (1.20m at sides)	635400 ○
1.50m (1.35m at sides)	636800 ○
1.65m (1.50m at sides)	635500 ○
1.80m (1.65m at sides)	636500 ○

*Standard drop of Concave and Convex panels is 150mm

- Stock items ■ Check for availability
- Made to order (cannot be cancelled once ordered)



I've now had 3 lots of Featherboard panels and posts from Jacksons and as usual the service & quality of the products were first class. Theirs is by far the best fencing we've ever had - the Jakcure® treatment really has prevented any deterioration. We have just extended a line of fencing erected two years ago & the new panels match the originals perfectly.

J Milne, June 2019



Featherboard Level Top

Featherboard Convex Top

Featherboard Concave Top



Due to the erratic price changes in raw material, we have temporarily removed prices from our Good Fencing Guide. To see our latest prices, view our Featherboard on our website by scanning the QR code.

Vertical Tongue & Groove Effect Panels

Our Vertical Tongue and Groove Effect panels are a mainstay of our premium panels range and are available with a Level or Convex Top.



Panels shown with optional capping rails.



They feature a mortice and tenon jointed frame for extra strength while the infill is constructed using Vertical Tongue and Groove Effect boards, which incidentally match the infill used on our Courtyard Gates, see pages 98 - 99.



The centre of the panel is given additional support with one 70mm wide rail for heights up to 1.22m, and two rails for heights of 1.52m and above. Panels are 1.83m wide, available in five heights from 0.91m to 1.83m with the option to use a panel width cut-down kit if required. Top and bottom rails are 70mm x 51mm planed with sides of 45mm x 51mm. Standard Tongue and Groove Effect panels have 21 pales.

Tongue and Groove Effect panels are designed for use with our slotted Jakposts, see pages 48 - 49, and manufactured from superior quality planed finish Jakcure® treated softwood, guaranteed for 25 years. Stainless steel fixings are used throughout for longer life. For matching Brook/Brabourne garden gates please see page 66.

To meet the conditions of the 25 year Jakcure® guarantee, gravel boards are required where panels are in contact with the ground.

**The chunky Diamond Trellis is only for use as a topper panel on Convex Tongue and Groove Effect panels (sold separately). The trellis measures 1.83m wide x 300mm high, with a planed finish. (745300 - £65.45).

Tongue & Groove Effect Panels (1.83m wide)

Level Top		Cut width kits	
Height	Ref	Height	Ref
0.91m	630100 ●	0.91m	630100K ●
1.22m	630200 ●	1.22m	630200K ●
1.52m	630300 ●	1.52m	630300K ●
1.65m	630000 ●	1.65m	630000K ●
1.83m	630400 ●	1.83m	630400K ●

Convex

Height* at highest point	Ref
1.52m	630310 ●
Cut width kit	630300K ●
1.83m	630410 ●
Cut width kit	630400K ●

*Convex panels standard drop is 150mm - on both sides

● Stock items ○ Made to order (cannot be cancelled once ordered)



Did You Know:

There is no need to apply any further timber protection treatment to your Jacksons Jakcure® treated product. Some customers might want to add colour to their Jacksons products. In these cases, please be aware that timber will naturally take a while to dry, during which, natural shrinkage can occur, so we recommend that you don't apply any colour coatings until the timber is fully dry and stable.



Vertical Tongue & Groove Level Top

Vertical Tongue & Groove Convex Top



Due to the erratic price changes in raw material, we have temporarily removed prices from our Good Fencing Guide. To see our latest prices, view our Tongue and Groove on our website by scanning the codes above.

Horizontal Tongue & Groove Effect Panels

Horizontal Tongue and Groove Effect panels are similar to their vertical counterpart panels making them a staple within our range, but the boards run horizontally and are only available with a Level Top.



Panels shown with optional capping rails.

They feature a mortice and tenon jointed frame for extra strength while the infill is constructed using horizontal Tongue and Groove Effect boards. The centre of the panel is given additional support with one 70mm wide rail for heights up to 1.22m, and two rails for heights of 1.52m and above.



Panels are 1.83m wide, with heights of 0.91m to 1.83m. Supporting rails are 45mm x 51mm and sides are 70mm x 51mm. Panels are available in five heights from 0.91m to 1.83m x 1.83mm wide with the option to use a panel width cut-down kit if required. Horizontal Tongue and Groove Effect panels have 21 pales.

Horizontal Tongue and Groove Effect panels are designed for use with our slotted Jakposts, see pages 48 - 49 and manufactured from superior quality, planed finish Jakcure® treated softwood, guaranteed for 25 years. Stainless steel fixings are used throughout for longer life. For matching garden gates please see page 68.

To meet the conditions of the 25-year Jakcure® guarantee, gravel boards are required where panels are in contact with the ground, see pages 50 - 51, and any timber cut on site must be treated with Jakcure® Cut Treatment, see page 53 or please visit our website.

Horizontal Tongue & Groove Effect Panels (1.83m wide)

Level Top		Cut width kits	
Height	Ref	Height	Ref
0.91m	632009 ○	0.91m	657100K ●
1.22m	632012 ○	1.22m	657200K ●
1.52m	632015 ○	1.52m	657300K ●
1.65m	632016 ○	1.65m	657350K ●
1.83m	630400 ●	1.83m	657400K ●

● Stock items ○ Made to order (cannot be cancelled once ordered)
■ Check for availability



Easy to order, delivered quickly & dropped by forklift on drive. Good quality construction fencing. Will place future order happily.

Mr Robinson, June 2020



Due to the erratic price changes in raw material, we have temporarily removed prices from our Good Fencing Guide. To see our latest prices, view our Horizontal Tongue & Groove fencing on our website by scanning the QR code.

Railing Toppers

Designed to fit on top of our premium framed panels, Railing Toppers add a touch of elegance and extra security to your garden.



Available in three styles; Level, Concave and Convex Top, the durable galvanised and powder coated steel panels feature finials and collars to alternate pales. Alongside added security, the other benefit of the slender metal topper panel is the extra light it offers, important if your garden suffers from lack of sunlight.



Like all of our panels, Railing Toppers slot easily into our sturdy Jakposts - see pages 48 - 49. All toppers are 1.83m wide. The Level Top panel is 450mm high. The Concave panel is 315mm at its lowest point, 450mm at the sides. The Convex panel is 585mm at the highest point and 450mm at the sides.

The top rail is constructed using 50mm x 6mm flat bar with 12mm vertical pales, while the bottom and side rails are of 50mm x 25mm steel box section, drilled with 6mm holes for fixing to the posts and fence top rail/wall for added rigidity and to prevent removal.

Manufactured from galvanised steel for extra long life and a 25 year service life guarantee. Polyester powder coated black as standard with a range of other colours available at additional cost.

Railing Topper Panels (1.83m wide)

Panel Type	Ref
Level Top	084101 ■
Concave	084201 ■
Convex	084301 ■

■ Check for availability



Due to the erratic price changes in raw material, we have temporarily removed prices from our Good Fencing Guide. To see our latest prices, view our Railing Toppers page on our website by scanning the QR code.

Hit & Miss Panels

Hit and Miss panels are so called because the boards are alternately fixed on the front and the back of the panel with an over-lap to create a stylish Hit and Miss pattern.



Horizontal panels with optional capping rails.

They are part of our premium 'good-both-sides' range so that both you and your neighbour have the best looking side of the fence, as both sides are the same. Hit and Miss panels are available with the boards running horizontally or vertically (please note that it is just about possible to see through the panels at certain angles).



Whichever contemporary style you choose, improved wind resistance is a bonus, as air can pass through the gaps.

Panels are 1.83m wide with a 45mm x 51mm frame planed. The spacing of boards varies slightly on different height horizontal Hit and Miss - for ease of alignment, we recommend vertical style panels are used when different heights are used in a run.

Our Hit and Miss panels are available in four heights, all at 1.83m wide and they are designed for use with our slotted Jakposts, see pages 48 - 49, and manufactured from quality, planed finish Jakcure® treated softwood, guaranteed for 25 years. We also use stainless steel fixings throughout for longer life. For matching gates please see pages 64 - 71.

To meet the conditions of the 25-year Jakcure® guarantee, gravel boards are required where panels are in contact with the ground, see pages 50 - 51. If you have to cut down a panel on site then use the following kit reference for all panel sizes. Always use Jakcure® Cut Treatment on cut timber, see page 53.

Hit & Miss Panels (1.83m wide)

Vertical		Horizontal	
Height	Ref	Height	Ref
0.91m	634300 ●	0.91m	631500 ●
1.22m	634200 ●	1.22m	631600 ●
1.52m	634100 ●	1.52m	631700 ●
1.83m	634000 ●	1.83m	634000 ●

Cut width kit

Height	Ref
1.83m	634000K ●

● Stock items



Inspirational

Many thanks to our customers who have shared their projects with us, without these inspirational images it would be difficult for us to show you the many ways that our products can be used.

If you have any photos of our products in your garden projects we'd love to see them, please email: pics@jacksons-fencing.co.uk



Due to the erratic price changes in raw material, we have temporarily removed prices from our Good Fencing Guide. To see our latest prices, view our Hit & Miss fencing page on our website by scanning the QR code.

Louvre Panels

Jacksons Louvre panels offer the sleek good looks suited to contemporary gardens. The horizontal slats are made from planed and shaped Jakcure® treated timber, secured to create an angle reminiscent of louvre blinds - unlike the flat profile of our Venetian fencing.



Panels shown with optional capping rails.



Rear view of Louvre panels.

The slats are also larger which gives greater privacy than Venetian - yet they still let in more light than solid styles like Chilham or Tongue and Groove Effect panels.



Oblique view of Louvre panels.



Excellent products that last so well. I have always noticed when you do need to cut anything, how much further Jacksons' preservative treatment has penetrated into the wood than any of their competitors. Maybe a little more expensive than some similar products, but worth the extra as far as I am concerned.

Mr Andrew King, July 2018

Louvre panels are designed for use with our slotted Jakposts, see pages 48 - 49, and manufactured from superior quality, planed finish Jakcure® treated softwood, guaranteed for 25 years.

Stainless steel fixings are used throughout for longer life. Four panel heights available, all at 1.83m wide. For garden gate options please see pages 64 - 71.

To meet the conditions of the 25-year Jakcure® guarantee, gravel boards are required where panels are in contact with the ground, see pages 50 - 51, and any timber cut on site must be treated with Jakcure® Cut Treatment, see page 53.

The panels can be cut to width on site with the original side batten being re-used in the new position.

Louvre Panels (1.83m wide)

Height	Ref
0.91m	658109 ○
1.22m	658112 ○
1.52m	658115 ■
1.83m	658118 ●

● Stock items ■ Check for availability
○ Made to order (cannot be cancelled once ordered)



Due to the erratic price changes in raw material, we have temporarily removed prices from our Good Fencing Guide. To see our latest prices, view our Louvre fence panels on our website by scanning the QR code.

Venetian Panels

One of our most popular styles and a favourite of garden designers. The strikingly attractive Venetian panel is another panel ideal for creating a dramatic light and shade effect in your garden as it allows light to pass between its horizontal slats.



Panels shown with optional capping rails.

These slatted panels create a contemporary fence that is less imposing than solid panels, making gardens feel larger. They are designed for use with our slotted Jakposts, see pages 48 - 49, and manufactured from superior quality, planed finish Jakcure® treated softwood.



We also use stainless steel fixings throughout for longer life. Six panel heights are available, all at 1.83m wide. A panel width cut-down kit is also available. Spacing between pales - 15mm.

For matching gates please see page 69.

To meet the conditions of the 25-year Jakcure® guarantee, gravel boards are required where panels are in contact with the ground, see pages 50 - 51, and any timber cut on site must be treated with Jakcure® Cut Treatment, see page 53.

Venetian Panels (1.83m wide)

Height	Ref	Cut width kit	
		Ref	
0.61m	657000 ●	657000CK ●	
0.91m	657100 ●	657100CK ●	
1.22m	657200 ●	657200CK ●	
1.52m	657300 ●	657300K ●	
1.65m	657350 ●	657350K ●	
1.83m	657400 ●	657400K ●	

Always use Jakcure® Cut Treatment on cut timber, see page 53.

● Stock items



Jacksons supplied excellent quality fence panels, I thought they were a bit expensive, but now they are installed, I'm pleased we spent the extra money.

Good solid panels no splits, no bits missing, no knots that have fell out and left a big hole, just good solid panels. Considered painting them but decided against it as they look too nice as they are!

Trev, July 2019



Due to the erratic price changes in raw material, we have temporarily removed prices from our Good Fencing Guide. To see our latest prices, view our Venetian fence panels on our website by scanning the QR code.

Venetian Hit & Miss Panels

Just like our original Venetian panel, the frameless Venetian Hit and Miss panel retains a contemporary and sleek look that complements both modern and traditional gardens.



Here our Venetian Hit & Miss are installed with two 0.907m panels stacked to create a 1.807m high panel. Photo also shows recommended capping.



Venetian Hit and Miss panels are part of our 'good-both-sides' range and feature horizontal slats on both sides of the panel with an over-lap which means air and light can still pass through, but visibility through the panel is largely obscured.



Constructed using 45mm x 16mm horizontal slats with a gap between the slats of approximately 30mm (which is larger than standard Venetian).

Venetian Hit and Miss panels are designed for use with our slotted Jakposts, see pages 48 - 49, and manufactured from superior quality, planed finish Jakcure® treated softwood, guaranteed for 25 years. Stainless steel fixings are used throughout for longer life.

The additional slats required to make these panels 'good-both-sides', also makes them quite heavy, so for ease of handling we offer them in two heights both at 1.83m wide. You can also cut panel widths on site using the specified cut down kit below. To achieve a taller fence, the panels can be stacked - for example stacking two 0.907m panels will give you 1.81m high.

We recommend using capping rails to add the finishing touch to these frameless panels. For matching garden gates please see page 68.

Please note: badges must be installed on same side to ensure alignment of pales both sides.

To meet the conditions of the 25-year Jakcure® guarantee, gravel boards are required where panels are in contact with the ground, see pages 50 - 51, and any timber cut on site must be treated with Jakcure® Cut Treatment, see page 53.

Venetian Hit & Miss Panels (1.83m wide)

Height	Ref	Cut width kit	
		Height	Ref
0.607m	657806 ●	0.607m	657806K ●
0.907m	657809 ●	0.907m	657809K ●

If you have to cut down a panel on site then use the above kit references. Always use Jakcure® Cut Treatment on cut timber, see page 53.

● Stock items



Did You Know:

There is no need to apply any further timber protection treatment to your Jacksons' Jakcure® treated product. Some customers might want to add colour to their Jacksons products. In these cases, please be aware that timber will naturally take a while to dry, during which, natural shrinkage can occur, so we recommend that you don't apply any colour coatings until the timber is fully dry and stable.



Due to the erratic price changes in raw material, we have temporarily removed prices from our Good Fencing Guide. To see our latest prices, view our Venetian fence panels on our website by scanning the QR code.

Aran Panels

The Aran panel is one of our 'good-both-sides' designs and features slats of different widths, intertwined to create a unique and attractive traditional style.



The interwoven design not only creates subtle light and shade effects in your garden but also means that both you and your neighbour benefit from the best looking side of the fence with almost as much privacy as you would expect from a solid panel.



Aran panels are designed for use with our slotted Jakposts, see pages 48 - 49, and manufactured from superior quality, planed finish Jakcure® treated softwood, guaranteed for 25 years.

Stainless steel fixings are used throughout for longer life. Available as a 1.83m high by 1.83m wide panel. Our Woven gates complement this panel (pages 64 - 71).

To meet the conditions of the 25-year Jakcure® guarantee, gravel boards are required where panels are in contact with the ground, see pages 50 - 51, and any timber cut on site must be treated with Jakcure® Cut Treatment, see page 53.

Aran Panels (1.83m wide)

		Cut width kit	
Height	Ref	Height	Ref
1.83m	656618 ○	1.83m	656600K ●

If you have to cut down a panel on site then use the following kit reference. Always use Jakcure® Cut Treatment on cut timber, see page 53.

● Stock items. ○ Made to order (cannot be cancelled once ordered)

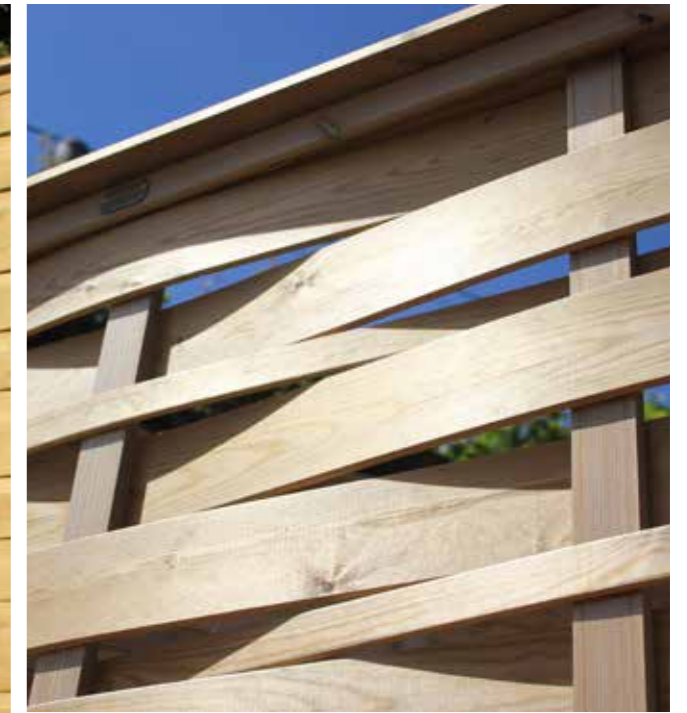

Purchased a 6ft single fence panel and a side gate (along with posts, gravel board etc) which were delivered within the specified time, in fact it came a couple of days earlier. The delivery driver helped to offload the fences to a safe place to the side rather than just dump it on the front driveway which some other companies do. The product quality is fantastic with a neat finish and reasonably priced. Really pleased with the purchase and would definitely use them again.

Assad F, June 2018



Due to the erratic price changes in raw material, we have temporarily removed prices from our Good Fencing Guide. To see our latest prices, view our Aran fence panels on our website by scanning the QR code.

Mitre Panels

Inspired by our traditional Palisade fence panels, the Mitre panel features 45mm x 16.5mm pales with an elongated curved top for a traditional picket design with a little more elegance, making it equally at home in a rural or urban setting.



It's perfect for front gardens or situations where natural light takes priority over privacy. Mitre panels are designed for use with our slotted Jakposts, see pages 48 - 49, and manufactured from superior quality, planed finish Jakcure® treated softwood, guaranteed for 25 years.



Stainless steel fixings are used throughout for longer life. Available as a 1.00m or 1.20m high by 1.83m wide panel.

To meet the conditions of the 25-year Jakcure® guarantee, gravel boards are required where panels are in contact with the ground, see pages 50 - 51, alternatively pales can be installed 50mm clear of the ground. Any timber cut on site must be treated with Jakcure® Cut Treatment, see page 53.

Mitre Panels (1.83m wide)

Height	Ref	Price
1.00m	229010 ○	£40.90
1.20m	229012 ○	£47.60

Gate Options	Ref
0.95m RH Gate	229100 ○
0.95m LH Gate	229110 ○
1.15m RH Gate	229200 ○
1.15m LH Gate	229220 ○

○ Made to order (cannot be cancelled once ordered)



The gate and posts I ordered are very good quality and the instructions provided meant I could install them easily. They were delivered promptly and the delivery man was really helpful and friendly. I'm very pleased with the finished result which enhances my property.

Ray Cranston, November 2019



Due to the erratic price changes in raw material, we have temporarily removed prices from our Good Fencing Guide. To see our latest prices, view our Mitre fence panels on our website by scanning the QR code.

Metro Panels

Metro was designed to make gardens feel longer - a modern take on our Venetian panels, posts are installed behind panels to create a continuous look, offering a sleek, slatted fence that is less imposing than a solid design.



Metro is a semi-solid decorative panel, ideal for creating a lighter garden where privacy is not an issue. This panel has been designed with an urban motif in mind, featuring singular pales, similar to our Venetian panels.



The key difference is that the fence posts are less visible, meaning that, when installed, the panel will appear as continuous slats, rather than a run of individual panels.

This style of panel has been designed to make gardens appear longer. Nevertheless, this panel has the ability to modernise and blend into country gardens with its contemporary design.

Constructed from Jakcure® treated softwood, the Metro Panels use our 91mm x 91mm square planed posts with stainless steel nails used throughout for longer life. Constructed using 45mm x 16mm horizontal slats with a gap between the slats of approximately 30mm (which is larger than standard Venetian).

Please note: Venetian gates complement this panel (see page 69), although Venetian has 15mm spacing and these panels have 30mm spacing.

Gravel boards need to be used when panels are in contact with the ground as part of the 25 year Jakcure® guarantee conditions. This panel uses a unique gravel board (see below).

0.907m high - 12 pales 45mm x 16mm (Venetian section).
0.607m high - 8 pales 45mm x 16mm 1.82m wide.
2 no. vertical battens 45mm x 34mm, 2 no. 45mm x 16mm.

Please ask for advice when installing panels into a corner as internal battens will be required.

Metro Panels (1.83m wide)

Height	Ref	Cut width kit	
		Height	Ref
0.607m	657906 ○	0.607m	657906K ○
0.907m	657909 ○	0.907m	657909K ○

	Ref
Gravel Board	667620 ○
Metro Panel Internal Corner Batten 1.80m long	667300C

○ Made to order (cannot be cancelled once ordered)



Did You Know:

There is no need to apply any further timber protection treatment to your Jacksons Jakcure® treated product. Some customers might want to add colour to their Jacksons products. In these cases, please be aware that timber will naturally take a while to dry, during which, natural shrinkage can occur, so we recommend that you don't apply any colour coatings until the timber is fully dry and stable.



Due to the erratic price changes in raw material, we have temporarily removed prices from our Good Fencing Guide. To see our latest prices, view our Venetian Metro fence panels on our website by scanning the QR code.

Chilham Panels

It's a challenge to design a solid timber fence that looks equally 'good on both sides'. However, our Chilham panels manage just that, in a unique design, free from horizontal rails that could spoil either yours or your neighbour's view.



Panel shown with Premier Square Trellis Topper

Our Chilham fencing presents an attractive 'panelled' appearance at home in a contemporary garden and due to its construction, is sturdy too. It looks equally at home in a traditional English cottage garden setting as it does in a sleek urban setting.



Chilham panels are designed for use with our slotted Jakposts, see pages 48 - 49, and manufactured from superior quality, planed finish Jakcure® treated softwood, guaranteed for 25 years.

Stainless steel fixings are used throughout for longer life. Four panel heights available, all at 1.83m wide and for matching gates see page 69.

To meet the conditions of the 25-year Jakcure® guarantee, gravel boards are required where panels are in contact with the ground - pages 50 - 51, and any timber cut on site must be treated with Jakcure® Cut Treatment, see page 53.

Chilham Panels (1.83m wide)

		Cut width kits	
Height	Ref	Height	Ref
0.91m	656000 ●	0.91m	656000K ●
1.22m	656100 ●	1.22m	656100K ●
1.52m	656200 ●	1.52m	656200K ●
1.65m	656165 ●	1.65m	656165K ●

● Stock items



Panels shown with optional Acorn postcaps



Ordered fencing and posts very easily online. Order confirmed within minutes. Communication was very good regarding delivery. Delivered on the right day and time, quality excellent.

Caroline, October 2019.



Panels shown with optional capping rails.



Panels shown with optional Acorn postcaps



Due to the erratic price changes in raw material, we have temporarily removed prices from our Good Fencing Guide. To see our latest prices, view our Chilham fence panels on our website by scanning the QR code.

Woven Panels

Part of our 'good-both-sides' panels range, Woven is designed with the traditional interwoven styles of the past in mind.



As with all Jacksons panels, they are constructed from Jakcure® pressure treated softwood and framed for use with slotted Jakposts, making them far stronger than traditional versions of this style of fencing.



Panels shown with optional capping rails.

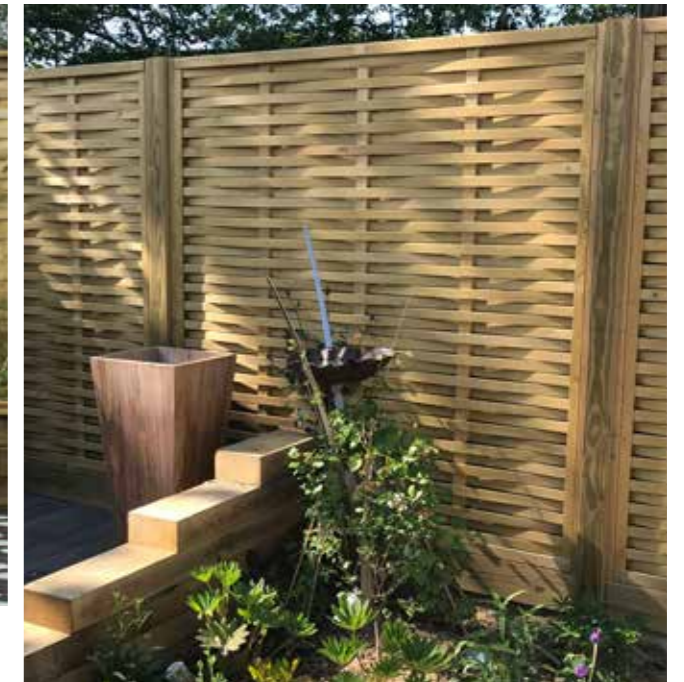

Woven panels feature substantial 38mm x 7mm planed pales that maintain the structural integrity of the panel which are then fitted into a strong frame.

Mid rails are less obtrusive by design, so you and your neighbours are both winners. Other benefits of our Woven panel is that it creates amazing dappled light and shade effects and, while it provides a high level of privacy, wind resistance is lowered due to air being able to pass through the spaces between the slats.

Woven panels are designed for use with our slotted Jakposts, see pages 48 - 49, and manufactured from superior quality, planed finish Jakcure® treated softwood, guaranteed for 25 years. Stainless steel fixings are used throughout the fencing for longer life.

Four panel heights available, all at 1.83m wide along with a panel width cut-down kit.

For matching gates please see page 69.

To meet the conditions of the 25-year Jakcure® guarantee, gravel boards are required where panels are in contact with the ground, see pages 50 - 51, and any timber cut on site must be treated with Jakcure® Cut Treatment, see page 53.

Woven Panels (1.83m wide)

Height	Ref	Cut width kits	
		Height	Ref
0.91m	656700 ■	1.83m	656600K ●
1.22m	656800 ■		
1.52m	656500 ●		
1.83m	656600 ●		

If you have to cut down a panel on site then use the above kit reference. Always use Jakcure® Cut Treatment on cut timber, see page 53.

● Stock items ■ Check for availability



Inspirational

Many thanks to our customers who have shared their projects with us, without these inspirational images it would be difficult for us to show you the many ways that our products can be used.

If you have any photos of our products in your garden projects we'd love to see them, please email: pics@jacksons-fencing.co.uk



Due to the erratic price changes in raw material, we have temporarily removed prices from our Good Fencing Guide. To see our latest prices, view our Woven fence panels on our website by scanning the QR code.

Canterbury Combi Panels

These premium contemporary panels combine the style of two of Jacksons' most popular products: horizontal Tongue and Groove, and our ever-popular Venetian, hand crafted from pressure treated timber.



Panels shown with recommended capping rails and our latest 'frameless design' for a more continuous look.



Rear view of panel without capping rail

Canterbury Combi lends a sleek, modern and linear look to any garden, with the added benefits of privacy and protection from the wind that some customers may prefer. Please note the slatted pale spacing is different on these panels when compared with a standard Venetian panel.



“
Great quality fence, looks great, delivery was spot on and. Will order from them again.
Darren Cremins, July 2020.

Canterbury Combi panels are designed for use with our slotted Jakposts, see pages 48 - 49, and manufactured from superior quality, planed finish Jakcure® treated softwood, guaranteed for 25 years and fitted with stainless steel fixings throughout for longer life.

Available panel size is 1.83m high x 1.83m wide along with a panel width cut-down kit.

For matching gates please see pages 64.

To meet the conditions of the 25-year Jakcure® guarantee, gravel boards are required where panels are in contact with the ground - pages 50 - 51, and any timber cut on site must be treated with Jakcure® Cut Treatment, see page 53.

Please Note: from February 2018 our Canterbury Combi panels have been modified to ensure a contemporary design. Should you require panels as per our pre-February 2018 design please do let us know.

Canterbury Combi Panels (1.83m wide)

Level Top		Cut width kits	
Height	Ref	Height	Ref
1.83m	658018 ●	1.83m	658018K ●

If you have to cut down a panel on site then use the above kit reference. Always use Jakcure® Cut Treatment on cut timber, see page 53.

● Stock items ■ Check for availability



Panels shown with optional capping rails.



Due to the erratic price changes in raw material, we have temporarily removed prices from our Good Fencing Guide. To see our latest prices, view our Canterbury Combi fence panels on our website by scanning the QR code.

Urban Panels

Combining wide and narrow timber pales, Urban is a contemporary panel with a distinctive design, ideal for a variety of applications. Mortice and tenoned for extra strength, these panels are planed all round for a smooth finish, with stainless steel fixings throughout to ensure a long life.



Built using our Hit and Miss pales combined with our Woven slats this panel has been designed to offer a look good one both sides. Urban can also be rotated so the pales run vertically and installed in the same way.



“
 Fantastic product. Good quality timber used to make the fence panels and measurements were all spot on. Thank you too for a speedy delivery.
 Matthew Thomas, October 2019.

Urban panels are designed for use with slotted Jakposts, see pages 48 - 49, and manufactured from superior quality, planed finish Jakcure® treated softwood, guaranteed for 25 years.

Pale sizes are 95mm x 8mm and 38mm x 7mm.

Available panel size is 1.83m high x 1.83m wide along with a panel width cut-down kit. These panels can also be rotated so pales run vertically.

For matching gates please see pages 68 - 69.

Please note: badges must be installed facing the same way to ensure alignment of pales on both sides.

To meet the conditions of the 25-year Jakcure® guarantee, gravel boards are required where panels are in contact with the ground - pages 50 - 51, and any timber cut on site must be treated with Jakcure® Cut Treatment, see page 53.

Urban Panel (1.83m wide)

Level Top		Cut width kits	
Height	Ref	Height	Ref
1.83m	685418 ■	1.83m	634000K ●

If you have to cut down a panel on site then use the following kit reference. Always use Jakcure® Cut Treatment on cut timber, see page 51.

■ Check for availability



Due to the erratic price changes in raw material, we have temporarily removed prices from our Good Fencing Guide. To see our latest prices, view our Urban fence panels on our website by scanning the QR code.

Shadowline Panels

Built with architectural cladding in mind, our Shadowline Panel has a modern unique profile which provides a dynamic central shadow gap between each board, free of any visible fixings, to provide a seamless contemporary finish.

These contemporary panels offer you the option to install a solid privacy style fence with no lines of sight through the panel which creates a clear shadow line between each board.



All panels shown with recommended capping rails.

Our Shadowline Panel offers a modern and contemporary clad design, similar to Tongue and Groove, and is highly recommended for homeowners looking for something a bit different.



Shadowline panels are constructed using 'Z shaped' 144mm x 26mm horizontal boards which overlap. Each panel is manufactured using 4x 70mm x 24mm back rails.

Our Shadowline panels are designed for use with our slotted Jakposts, see pages 48 - 49, and manufactured from superior quality, planed finish Jakcure® treated softwood, guaranteed for 25 years. Stainless steel fixings are used throughout for longer life.

Our 0.66m high panels are made with 5 boards.
Our 0.91m high panels are made with 7 boards.
Panels are 1.83m wide.

To achieve a taller fence, the panels can be stacked - for example stacking 2x 0.91m panels will give you 1.8m high approx. You could use 2x 0.66m panels for a 1.3m high panel approx or alternatively combine one of each height for 1.55m. It is not obvious in any way that these panels are stacked and once installed they will appear as one continuous panel.

We recommend using capping rails to add the finishing touch to these frameless panels. For garden gate options please ask.

To meet the conditions of the 25-year Jakcure® guarantee, gravel boards are required where panels are in contact with the ground, see pages 50 - 51, and any timber cut on site must be treated with Jakcure® Cut Treatment, see page 53.

Shadowline Panel (1.83m wide)

Height	Ref	Cut width kit	
		Height	Ref
0.66m	658606 ■	0.66m	658606K ■
0.91m	658609 ■	0.91m	658609K ■

■ Check for availability



Excellent delivery driver, helped me out tremendously. Very friendly. The fences and extras themselves are a very high standard. Would recommend and order again with Jacksons.

M Spencer, November 2019.



Due to the erratic price changes in raw material, we have temporarily removed prices from our Good Fencing Guide. To see our latest prices, view our Shadowline fence panels on our website by scanning the QR code.

Jaktop Panels

Our Jaktop panels and gates grace many front gardens in rural and suburban areas and offer a decorative alternative to palisade or picket style fencing.



The criss-cross pattern constructed using half round timber pales gives the panels a very distinctive look while the addition of sturdy rails and vertical end pales create a fixed panel suitable for use with slotted Jakposts, see pages 48 - 49.



This is my second project using Jacksons, the quality of the fencing is the best and I could not find anything that got near to the quality of the fencing supplied. Very helpful when ordering and also offering advice. Delivery was within the specified time and I had a call from the driver prior to my delivery being made.

Graham Harvey, August 2019.



Additionally, Jaktop panels need to be mounted a minimum clear of the ground. Stainless steel fixings are used throughout for longer life.

Available in two heights at 1.83m wide. Jaktop panels can be cut to width on site, with the original side batten re-used.

For matching gates please see page 70.

Please note: this product can be installed without the use of gravel boards providing there is at least a 50mm ground clearance and/ or the item remains unaffected by any debris. However to meet the conditions of the 25-year Jakcure® guarantee, gravel boards are required where panels are in contact with the ground - pages 50 - 51. Any timber cut on site must be treated with Jakcure® Cut Treatment, see page 53.

Jaktop Panels (1.83m wide - for use with slotted posts)

Height	Ref
0.86m	600600 ■
1.20m	600700 ■

■ Check for availability



Due to the erratic price changes in raw material, we have temporarily removed prices from our Good Fencing Guide. To see our latest prices, view our Jaktop fence panels on our website by scanning the QR code.

Palisade Panels

Palisade is a classic and enduring style of garden fencing that is also known as picket fencing and is available with pointed or rounded pales.



Palisade panels are designed for use with our slotted Jakposts, see pages 48 - 49 and manufactured from superior quality, planed finish Jakcure® treated softwood, guaranteed for 25 years and complete with stainless steel fixings throughout for longer life.



“

As a previous customer and now as a registered installer of their fencing, I can honestly say that we are full converts to their far superior products, there is simply no better fencing and the service is equally good.

Bowood Landscapes, August 2019.



For matching gates please see pages 70.

To meet the conditions of the 25-year Jakcure® guarantee, gravel boards are required where panels are in contact with the ground, see pages 50 - 51, alternatively panels can be installed 50mm clear of the ground. Any timber cut on site must be treated with Jakcure® Cut Treatment, see page 53.

All panels are 1.83m wide. Pales are 22mm x 75mm nominal section planed to finish at 19mm thick. Pale tops are machined. Each panel is backed by two substantial rails which have been fully planed.

Palisade Level Top Panels (1.83m wide)

Rounded Tops		Pointed Tops	
Height	Ref	Height	Ref
1.00m	223500 ●	1.00m	224500 ■
1.20m	223600 ●	1.20m	224600 ○

Panels can be cut to width on site without the need for a cut width kit. Always use Jakcure® Cut Treatment on cut timber, see page 53.

- Stock items ■ Check for availability
- Made to order (cannot be cancelled once ordered)



Due to the erratic price changes in raw material, we have temporarily removed prices from our Good Fencing Guide. To see our latest prices, view our Palisade fence panels on our website by scanning the QR code.

Traditional Palisade or Picket Fencing

Traditional Palisade fencing is also known as picket fencing. 'Traditional' fencing is a term we use to describe a system of fencing made from vertical posts and horizontal rails, with pales fixed to the rails, supplied in kit form rather than panel form.



Pales are nominal 75mm x 22mm section, (70mm x 19mm planed finished size) planed with pointed or rounded tops with pale tops machined. When calculating materials required, you will need one post for every 2.28m plus one extra for the end of the run. There are 14 pales per bay. Each bay is backed by two 2x 87 x 38mm nominal rails.



The fence should be erected 50mm above ground level to allow for weeding, and to keep it clear of the ground.

Posts for 1.00m and 1.20m high fences are of a nominal 100mm x 75mm section and have two mortices with tops weathered two ways or rounded. Posts for 1.80m fences are of a nominal 125mm x 75mm section and have three mortices with tops weathered two ways or rounded. Corner posts measure a nominal 100mm x 100mm in section. Use two rails per bay for 1.00m and 1.20m high fences and three per bay for 1.80m high fences.

Manufactured from superior quality planed finish Jakcure® treated softwood, guaranteed for 25 years. All fittings and fixings are stainless steel. For matching gates see the gates section - page 70. To meet the conditions of the 25-year Jakcure® guarantee, gravel boards are required where panels are in contact with the ground, see pages 50 - 51, alternatively pales can be installed 50mm clear of the ground. Any timber cut on site must be treated with Jakcure® Cut Treatment, see page 53.

Posts - Traditional Palisade

Fence Height	Post Height	Rounded Tops		Pointed Tops	
		Post Ref		Post Ref	
1.0m	1.50m	223100 ●		220100 ●	
1.2m	1.80m	224100 ●		221300 ■	
1.8m	2.40m	225400 ●		225500 ○	

Corner Posts - Traditional Palisade

Fence Height	Post Height	Rounded Tops		Pointed Tops	
		Post Ref		Post Ref	
1.00m	1.50m	223200 ●		220800 ●	
1.20m	1.80m	224200 ●		222000 ■	
1.80m	2.40m	225600 ■		225700 ○	

Pales - Traditional Palisade (14 per section)

Height	Rounded Tops		Pointed Tops	
	Ref		Ref	
1.00m	223000 ●		220400 ●	
1.20m	224000 ●		221600 ●	
1.80m	225200 ●		225300 ○	



Good website that makes buying fencing quite easy. Panels come with 25 year warranty and look much better than those bought from the big stores. Delivery within days.

M. White, July 2019.

Rails - Traditional Palisade

Size	Ref
2.40m long, nominal 87mm x 38mm section, scarfed both ends	221700 ●

Nails

Stainless steel nails 50mm. 1kg covers 11m for 1.00m and 1.20m. 1kg covers 7.00m for 1.80m.	Size	Ref
	1 kg	800710 ●
	5 kg	800750 ●

Traditional fencing can be cut to width on site without the need for a cut width kit. Always use Jakcure® Cut Treatment on cut timber, see page 53.

- Stock items ■ Check for availability
- Made to order (cannot be cancelled once ordered)



Due to the erratic price changes in raw material, we have temporarily removed prices from our Good Fencing Guide.

To see our latest prices, view our Palisade or picket fencing panels on our website by scanning the QR code.

Traditional Closeboard or Featherboard

Traditional Featherboard is also known as Closeboard or Featheredge fencing. 'Traditional' fencing is a term we use to describe a system of fencing made from vertical posts and horizontal rails and gravel boards, with pales fixed to the rails, supplied in kit form rather than panel form.



Panels above and on the right all shown with optional capping rails.

Featherboard fencing is supplied in sawn finish Jakcure® treated softwood. The pales are taper sawn to produce a nominal 2x 100mm x 22mm section board, they are finished 150mm shorter than the height of the fence to stand on a 150mm gravel board as standard.



Due to the erratic price changes in raw material, we have temporarily removed prices from our Good Fencing Guide.

To see our latest prices, view our Traditional Featherboard fencing on our website by scanning the QR code.

Posts are a nominal 125mm x 100mm in section for extra strength. The 1.20m fence posts feature two recesses, while the 1.50m and 1.80m versions have three recesses to accommodate the rails. Post tops are weathered in one direction. Supplied in a natural Jakcure® treated finish.

When calculating materials required, you will need one post and 29 pales per 2.40m bay plus one extra post for the end of the run.

Manufactured from superior quality Jakcure® treated softwood, guaranteed for 25 years. For matching gates see the gates section - page 65.

To meet the conditions of the 25-year Jakcure® guarantee, gravel boards are required where pales are in contact with the ground. Any timber cut on site must be treated with Jakcure® Cut Treatment, see page 53.

Traditional Featherboard Pales

Fence height with gravel board	Pale Height	Ref
1.05m	0.90m	232300 ●
1.20m	1.05m	230400 ●
1.35m	1.20m	232400 ●
1.50m	1.35m	230500 ●
1.65m	1.50m	232500 ●
1.80m	1.65m	230600 ●
1.95m	1.80m	232600 ●

Guide Price per metre - Height: 1.20m £31.73, 1.50m £40.14, 1.80m £44.57. Price includes cement, ballast and nails.

Traditional Featherboard Posts

Inter posts - 125mm x 100mm section recessed for rails 2 or 3 times according to height.

Corner Posts - 125mm x 125mm weathered two ways.

Fence Height	Post Height	Post		Corner Post	
		Ref		Ref	
1.20m	1.80m	230100 ●		230800 ●	
1.50m	2.40m	230200 ●		230900 ■	
1.80m	2.70m	230300 ●		231000 ●	

Traditional Featherboard Gravel Boards

Size	Ref
2.40m x 150mm x 25mm	230700 ●

Traditional Featherboard Capping

Capping for traditional Featherboard fencing. Planed timber capping rail, with counter rail and two L shaped brackets.

Size	Ref
2.40m kit with fixings	232200BM ●

Traditional Featherboard Rails

Size	Ref
2.40m x 85mm x 36mm weathered	231400 ●

Nails

	Size	Ref
Galvanised 75mm nails for attaching rails & gravel boards 1kg. for 23.00m.	1kg	800210 ●
	5kg	800250 ●
Stainless steel 50mm nails for attaching pales 1kg. for 9.00m.	1kg	800710 ●
	5kg	800750 ●

● Stock items

Slotted Jakposts & Square Posts

We manufacture a wide range of fence posts to suit our fence panels and trellis. Slotted Jakposts® are our most popular post option. Available in standard and heavy duty inters, ends, and corners, panels simply slide into posts and fit snugly to stop rattling, and can be securely fixed with screws. New for 2022, our angled slotted fence posts allow corners between 30-45 degrees, adding another option for gardens without sharp 90 degree corners.



Jakposts are 95mm x 98mm, planed finish with two 54mm x 25mm slots for panels. All panels slot easily into position as shown here.

Installation instructions for most of our products are available from our website: www.jacksons-fencing.co.uk. Alternatively, we can supply you with a copy on request.

We have listed below some of the many benefits to using Jakposts:

- Jakcure® treated softwood guaranteed for 25 years.
- Environmentally friendly.
- Jakposts reduce damage caused by wind movement when panels are screwed to posts.
- Unlike concrete posts, there is no risk of frost damage, cracks or chips.
- Easy to carry and lighter than concrete posts.
- More supportive than square section posts, avoids gaps between panels and posts.
- Stainless steel nails used throughout.
- More natural appearance than concrete posts.

NEW Angled Fence Posts

Our angled slotted Jakpost® has been designed to help with those tricky fence runs.

Not every garden or fence run is straight or every corner 90 degrees. Therefore, we have designed and manufactured an angled fence post allowing a change of direction between 30 to 45 degrees.

Only supplied in 2.7m but can be cut to size on site to suit lower fence heights.

We generally recommend that all posts should be set in concrete at a minimum 0.60m into the ground. Please ask for advice when sizing gate posts.

Square Section Panel Posts

Planed finish (not slotted). These are standard square section posts without the unique slot that our superior slotted Jakposts have. It is advisable to fix panels to posts with Jakclips when using standard posts. See page 153.

Recommended Fixings

We recommend using 6 screws per panel or 12 per panel if using capping rails plus an additional 4 per gravel board. 60mm, stainless steel, self-drilling countersunk screws are available in packs of 100 or 200 to secure panels to posts. Panels should be screwed to the posts to secure the fence run.

- Stock items
- Check for availability

Slotted Jakposts

Posts are 100mm x 100mm with two 54mm x 25mm slots for panels.

Fence Height	Post Height	Intermediate Posts		Corner Posts		End Posts		Angled posts	
		Ref		Ref		Ref		Ref	
0.60m	1.06m	756200 ●		756300 ●		756100 ●			
0.90m & 0.75m	1.50m	667200 ●		667220 ●		668200 ●			
1.05m & 1.20m	1.80m	667300 ●		667330 ●		668300 ●			
1.35m & 1.50m	2.10m	667400 ●		667440 ●		668400 ●			
1.65m & 1.80m	2.40m	667500 ●		667550 ●		668500 ●			
2.00m	2.70m	667800 ●		667880 ●		668800 ●		667881NC ■	

* Angled posts are only supplied in 2.7m but can be cut to size on site to suit lower fence

Heavy Duty Jakposts

Posts are 120mm x 124mm with two 54mm x 25mm slots for panels.

Post Height	Intermediate Posts		Corner Posts		End Posts	
	Ref		Ref		Ref	
2.70m	669000 ●		669010 ●		669011 ●	
3.00m	669100 ●		669110 ●		669111 ●	
3.30m*	669200 ●		669220 ●		669222 ●	
3.60m*	669300 ●		669330 ●		669333 ●	
3.90m*	669400 ●		669440 ●		669444 ●	

*Posts are intended to be used for more varied locations and fences of extended height.

Heavy Duty Square Posts

Size: 91mm x 91mm (planed dimension before treatment) Jakcure® treated posts for hanging light gates etc.

Post Height	Ref
1.20m	641100 ■
1.50m	641200 ●
1.80m	641300 ●
2.10m	641400 ●
2.40m	641500 ●
2.70m	641600 ●
3.00m	641700 ●
3.30m	641800 ●
3.60m	641900 ●

Locations with strong winds require stronger posts or for them to be dug deeper into the ground - if you have any queries please ask for advice.

Standard Square Posts

Size: 70mm x 70mm (planed dimension before treatment)

Fence Height	Post Height	Ref
0.60m	1.20m	640100 ■
0.90m	1.50m	640200 ●
1.20m	1.80m	640300 ●
1.50m	2.10m	640400 ●
1.80m	2.40m	640500 ●
2.10m	2.70m	640600 ●

Screws

	Ref
Stainless Steel Self-Drilling Countersunk Torx Head Screw Pack of 200 60mm	809900 ●
Stainless Steel Self-Drilling Countersunk Torx Head Screw Pack of 100 60mm	809911 ●

Mi-T® Metal Garden Fence Posts

Our Mi-T® post is a modern, secure, and easy to maintain galvanised steel fence post suitable for use with our framed timber fence panels. Manufactured using high quality galvanised steel in the UK with a contemporary slimline design shaped like a 'T', these metal posts will not rot or rust and are guaranteed for 25 years. Their innovative design means they are virtually invisible from the front of the fence providing a contemporary, seamless finish in any garden.



Mi-T® Garden Fence Posts are 100% recyclable and offer a sustainable alternative to concrete posts. The 'T' shape allows Mi-T to be used as inter and corner posts.

Mi-T® is available in galvanised finished or powder coated Anthracite grey.

Designed for use with our 1.83m high framed panels and gravel board. Our framed panels are Tongue & Groove Effect, Venetian, Hit & Miss, Woven, Aran, Louvre, Urban and Premier Trellis.

Mi-T® Post Specification

Post Length: 2.7m to install 1.83m panel with gravel board
Steel Thickness: 6mm
50 x 50mm 'T' design
Hot Dip Galvanised to BS EN 1461 as standard

Mi-T® Posts

	Post Height	Ref
Galvanised Finish	2.70m	669990BM
Powder Coated Anthracite	2.70m	669991BM



Mi-T® Post Timber Cover Board

Timber cover board to hide visible side of galvanised Mi-T Post.

Ref
669900

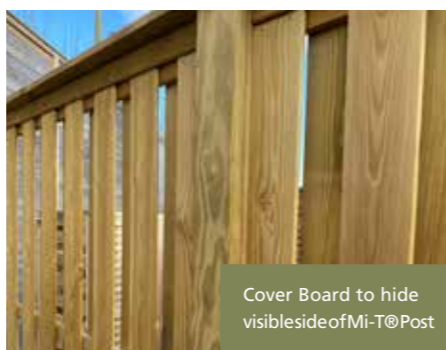

Our fence post feet offer an alternative to digging, when installing fencing on existing hard surfaces, such as concrete. With two options available for use with our Mi-T® post and Jakpost®, the feet are specially made to fit securely and are bolted down to concrete.



Digging a hole is not always possible, therefore we have produced a version of our Mi-T® post that includes a foot, allowing the post to be installed on a secure hard surface such as concrete.

Mi-T® Post Foot	Post Height	Ref
Galvanised post with foot	1.98m	669905BM ●
Anthracite post with foot	1.98m	669906BM ●

Our strong galvanised Jakpost® foot allows an intermediate standard slotted Jakpost® to be installed on a secure hard surface such as concrete. (Not for use with heavy duty slotted Jakposts®). When fence panels are installed into the slots, most of the bracket and fixings attached to the post are hidden.

When using Slotted Jakpost® feet, posts may need to be cut to length. The cut down post should be coated with Jakcure® cut treatment and the cut end of the post should be installed at the top.



Mi-T® Post Cover Boards can be used to cover the rear side of a galvanised Mi-T®



Due to the erratic price changes in raw material, we have temporarily removed prices from our Good Fencing Guide.

To see our latest prices, view our website by scanning the QR code.

Slotted Jakpost® Foot	Ref
Galvanised slotted post foot	669901BM ●



We have created this product due to frequent requests and while it may save time and make installations easier, every site and application is unique and this product may not be suitable. We take no responsibility for the structure and integrity of the surface the posts are fixed to and the choice of suitable fixings. We cannot accept any responsibility for the strength or durability of the fixing method, or the surface or wall it is fixed to, due to external factors such as wind loads and weathering of the surface or wall, or damage by force from vehicles, intruders climbing, etc.

Gravel Boards

Gravel boards are important in ensuring your fencing stays in good quality condition. Our gravel boards are made from a specific type of timber, which is different to the timber we use for our fencing and is Jakcure® treated specifically for constant ground contact which is integral to ensure we can guarantee our fencing for 25 years.



Due to the erratic price changes in raw material, we have temporarily removed prices from our Good Fencing Guide.

To see our latest prices, view our gravel boards on our website by scanning the QR code.

Gravel boards are also used to raise panels off the ground, give a fence extra height and add a finishing touch to a well put together run of fencing. All timber used throughout is premium quality Jakcure® treated softwood, guaranteed for 25 years.



Jacksons Supply Two Types of Standard Gravel Board:

The first is a gravel board for use with our slotted Jakposts. This version includes two spacer blocks that prevent the gravel board from movement when installed in the slotted posts. The spacer blocks can be purchased separately if spares are required (667601). We recommend gravel boards are screwed into position to prevent any movement.

The second gravel board type we offer is a 2.40m long x 140mm x 25mm (230700) typically used with Traditional Fencing such as Traditional Featherboard. This version will not work with our slotted Jakpost system.

When using two gravel boards to increase the height of a fence, the boards should be held together with a 600mm x 50mm x 50mm (644400) support post to prevent any distortion. This should be placed centrally and driven into the ground with the gravel boards screwed to it. Gravel boards are not intended to retain earth on one side of the fence without additional support.

To meet the conditions of the 25-year Jakcure® guarantee, gravel boards are required where panels are in contact with the ground and any timber cut on site must be treated with Jakcure® Cut Treatment, see page 53.

Gravel Boards	Ref
For use with slotted Jakpost - 1.83m long. 140mm x 28mm with 22mm packers	667600 ●
Not for use with slotted Jakpost - 2.40m long. 150mm x 25mm	230700 ●

Please note: for our Metro gravel boards see page 29.

Hedgehog Friendly Gravel Boards

In response to learning about the decline in hedgehog numbers in the UK - it has been estimated that the current population is down by half since 2000 according to a report published in The Guardian (2018) - Jacksons introduced a hedgehog friendly gravel board for use with Slotted Jakposts (shown above). We have been delighted with the response from the public and wildlife organisations to our raising awareness of this problem and offering a simple solution that allows hedgehogs to roam freely between gardens.

We offer a hedgehog friendly gravel board for use with Jakposts (667610) with a hole at one end, large enough to allow hedgehogs free passage and a reinforcing strip along the top of the board to ensure strength is retained. For more info about the plight of the Hedgehog, visit our website and search for 'Help the Hedgehogs'.

Hedgehog Gravel Boards	Ref
For use with slotted Jakpost - 1.83m long. 140mm x 28mm with 22mm packers	667610 ●

For a hedgehog friendly version of the Traditional Fencing (non-panel) gravel board, we suggest customers cut the gravel board on site and by using a small peg to support the fence rail, as shown in the photo. The support pegs are also used to prevent gravel boards distorting when more than one is used to increase fence height.

Support Peg	Ref
600mm x 50mm x 50mm	644400 ●

● Stock items

Capping Rails Finials & Post Caps

Post Caps, Finials and Capping Rails all add the final touches to a well put together run of fencing.



Some people may think a post without a Cap or Finial looks unfinished, you can judge this for yourself, the top photo on the right shows Ball Finials on the posts, which punctuate the curves of the Trellis Topper panels.



The photo above shows a single Featherboard panel which has been finished with a capping rail, running flush with the post and panel tops to give a crisp, contemporary look.

We offer a selection of Post Caps, Finials and Capping Rails, all manufactured from superior quality Jakcure® treated softwood, and all guaranteed for 25 years.

Standard Capping for Panels

Planned timber with 2 rounded edges

1.88m x 120mm x 20mm

Ref

667700 ●

2.00m x 120mm x 20mm
(for use at ends & corners)

Ref

667772 ●



Heavy Duty Capping Rail

For intermediate slotted posts
1.900m x 145mm x 35mm

Ref

667700H ■

For end and corner slotted posts
1.985m x 145mm x 35mm

Ref

667770H ■



Standard Capping for Panels



The first design is for use with standard slotted and square posts and is a flat style capping for fence panels, made from smooth planned timber with rounded edges. Use code 667700 for capping to

be used between intermediate posts. Use code 667772 for capping to be used with end and corner posts.

Note: If you prefer capping to run over the tops of the posts then please use our standard panel capping.

Note: This capping should not be used if you want a totally flat finish where the tops of the post finish in line with the top of the panel.

Capping rail for use with intermediate slotted posts

Ref

1.88m x 120mm x 20mm

667700 ●



Jakcure® Cut Treatment

Where cutting or drilling treated timber cannot be avoided, always use Jakcure® Cut Treatment to ensure no timber is left untreated and the conditions of the 25-year Jakcure® guarantee are met. Read the instructions carefully.

500g bottle

Ref

131212 ●

● Stock items ■ Check for availability



Two-way chamfered capping

1.84m x 70mm x 26mm

Ref

667778



Post Caps and Finials (shown left from A - K)

Our range includes standard flat square post caps that are a simple finish to the top of a post, alternatively, our simple half round version will give the post a clean domed top. We also offer Decorative Ball and Acorn Finials which come complete with square cap.



Style A



Style B1 & B2



Style C



Style D



Style E



Style F



Style K

Style - All sizes nominal

A: for use with 75mm x 75mm posts

B1: for use with 100mm x 100mm posts

B2: for use with 125mm x 125mm posts

C: for use with 100mm x 100mm posts

D: for use with 75mm x 75mm posts

E: for use with 75mm x 75mm posts

F: for use with 100mm x 100mm posts

K: for use with 100mm x 100mm posts

Ref

640900 ●

641000 ●

640660 ●

668000 ●

645400BM ●

645600BM ●

645700BM ●

645880BM ●

Jakoustic® Acoustic Barriers

Welcome to reduced levels of environmental noise and a better quality of life. The proven and flexible Jakoustic® fencing is designed to shield your property from environmental noise pollution caused by traffic, machinery or people.



It improves your quality of life by allowing you to use areas of your garden that have become 'no-go' areas due to noise intrusion and, due to its design and substantial construction, it also provides a security fence that will protect you from unwanted visitors.



“

'It is now actually possible to have a normal conversation, instead of shouting. One great aspect is that as a result of the acoustic barrier being installed, we can now make full use of this area. We have created a seating/dining area underneath the large trees next to the Jakoustic®. It not only looks great, especially with the late afternoon sun, it is a peaceful area to relax in with a glass of something after the stresses of the day!'

Garden Designer - Mark Lane
installed Jakoustic® in his own garden





Jakoustic® Reflective Barrier with double leaf gates & J-lock



Taller heights possible with steel I-beam posts



Matching Automated Jakoustic® Gates



Panels shown with optional capping rails



Detail of a tuning fork post with first few boards showing the unique 'V' profile

Jakoustic® is available in three barrier types: Reflective, 12k Envirofence® and Absorptive. Reflective works as its name suggests, by reflecting noise from its surface, and is the most commonly used type, we also offer a light weight option 12k Envirofence®. For situations with noise issues within a confined space where noise reflection could pose additional problems, Jakoustic® Absorptive is the solution as it is designed to absorb a high percentage of noise into its structure, rather than reflecting it.

Noise mitigation is usually a complex problem, so to ensure that you arrive at the best solution for your specific situation, we recommend consulting a qualified Sound Engineer before you make a purchase.

Please consult with one of our Acoustic Team for details on independent Sound Engineers we are happy to recommend.

The table below shows the results from measurements taken from laboratory testing:

Sound reduction achieved in tests on Jakoustic® barriers

Distance from Barrier	No Barrier	Fence Height 2m	Fence Height 2.5m	Fence Height 3m
5m	67.2dB	53.6dB	50.7dB	49.8dB
10m	61.5dB	50.2dB	48dB	47.7dB
15m	58dB	47.7dB	45.5dB	45.1dB
20m	55.2dB	46dB	43.3dB	42.8dB

The above data shows the results from measurements taken during a field trial, which simulated the latest British Standard test procedure for acoustic fencing in a practical location. The generated noise source was directly behind the barrier (length 9.6m).

As illustrated in the table, in ideal situations, a Jakoustic® barrier can reduce noise by more than 10 decibels (dB).

To put this into perspective, motorway traffic produces 70dB of noise while conversational speech produces 60dB, so a 10dB reduction is significant.

Jakoustic® Reflective

Jakoustic® Reflective barrier consists of 'tuning fork' posts, unique interlocking V tongue and groove boards, counter rail, capping rail and all associated fixings. The boards are machined to a finished size of 125mm x 34mm, making Jakoustic® one of the heaviest acoustic barriers in the market.

Jakoustic® barriers are available in heights from 2.00m to 3.00m. The height and type of the fence will be determined by the site conditions and also the recommendations of an acoustic survey as carried out by a specialist Sound Engineer. Please enquire directly with us for more details.

12k Envirofence®

We offer a lighter weight, lower cost alternative to the standard Jakoustic® noise barrier in the Jakoustic® 12K Envirofence® which uses 20mm thick by 125mm (nominal) boards. It is suitable for installations where the required noise reduction is less than that of the standard Jakoustic® noise barrier - or where a superficial mass of 10, 11 or 12 kg/m² is specified.

Jakoustic® Absorptive

Jakoustic® Absorptive acoustic fencing adds an absorptive layer on one side of a standard Jakoustic® barrier made up of a mineral Rockwool® fibre and protective membrane. It is ideal for applications where a noise source is in a tight confined area surrounded by reflective surfaces.

As with all Jacksons timber products, the timber used in all Jakoustic® barriers has been treated with the unique Jakcure® process which guarantees the product for 25 years against rot and insect attack.

For more information on Jakoustic® barriers including LPS1175 certified and Secured by Design versions, please contact our specialist Acoustic Team on: 0800 41 43 43.



Delivered on time, very helpful and polite delivery man. It was refreshing to see his lorry was fully equipped with a little fork lift to be able to transport the fencing up the gravel drive rather than leaving on the side of road. The fencing is great quality and looks great. Very pleased with Jacksons Fencing from start to finish.

S Hill, May 2019.



Closeup of the interlocking section

For more information or a quote please call our Acoustic team on: 0800 41 43 43

Residential Railings Barbican Imperial®

& Sentry®

Our Barbican Imperial® and Sentry® railings are perfect for both residential and larger housing projects. Both have 19mm pales with the Barbican Imperial® Residential railings offering an aesthetically pleasing slender round metal railing design with a range of finials to choose from, whilst our Sentry® Residential Railings offer rounded pales with a flat top rail giving them contemporary style.



Sentry® Residential Railings



Due to the erratic price changes in raw material, we have temporarily removed prices from our Good Fencing Guide. To view our latest prices, visit our website by scanning the QR code.



Barbican Imperial® Residential Railings

Barbican Imperial® Residential railings panel and posts are of hollow steel sections constructed in a fully welded, pale-through method with no visible joints. The fence panel to post fixing is by way of concealed, vandal resistant fixings. Decorative finials can be added with six different finial options available.

- Fence heights: 1.00m & 1.25m
- Posts: 60mm x 60mm rectangular hollow section
- Post centres: 3000mm
- Post lengths: 1.60m or 1.85m to allow for 0.60m in the ground
- Pales: Diameter 19mm circular hollow section
- Rails: 50mm x 25mm rectangular hollow section

Sentry® Residential Railings

Sentry® Residential Railings panels are fully welded and of tubular semi pale-through-rail construction, with concealed, vandal-proof panel to post fixings. Sentry® Residential Railings are ideally suited for use around decks and other raised areas where a strong, simple barrier is required. Please ask us for advice on fencing raised areas.

- Fence heights: 1.00m & 1.25m
- Posts: 60mm x 60mm rectangular hollow section
- Post centres: 3000mm
- Post lengths: 1.60m or 1.85m to allow for 0.60m in the ground
- Pales: Diameter 19mm circular hollow section
- Rails: 50mm x 25mm rectangular hollow section

Features & Benefits Common to Barbican Imperial® & Sentry® Railings

- Constructed from steel with a 25 year service life guarantee
- Pale spacing is at 100mm to conform to Building Regulations for anti trap
- Option to be base plated at extra cost
- Supplied galvanised and powder coated black as standard but other colours available
- Galvanised and powder coated to BS EN 13438 in other colours at extra cost
- Swing or sliding gates are available with either automated or manual operation options.

Please ask for specifications.

○ Made to order (cannot be cancelled once ordered)

Barbican Imperial® Residential Railings

	Panel Height	Ref
Galvanised & PPC	1.00m	979100 ○
Galvanised & PPC	1.25m	979120 ○
Intermediate Posts	1.00m	971001 ○
Intermediate Posts	1.25m	971251 ○
Corner Posts	1.00m	971003 ○
Corner Posts	1.25m	971253 ○
End Posts	1.00m	971002 ○
End Posts	1.25m	971252 ○
Connectors 4 each panel	-	020001 ○



Finials for Barbican® Imperial

	Ref		Ref
Finial 1	957010	Finial 4	957040
Finial 2	957020	Finial 5	957050
Finial 3	957030	Finial 6	957060

Sentry® Residential Railings

	Panel Height	Ref
Galvanised & PPC	1.00m	921000 ○
Galvanised & PPC	1.25m	921200 ○
Intermediate Posts	1.00m	921001 ○
Intermediate Posts	1.25m	921201 ○
Corner Posts	1.00m	921002 ○
Corner Posts	1.25m	921202 ○
End Posts	1.00m	921001 ○
End Posts	1.25m	921201 ○
Connectors 4 each panel	-	020001 ○

Bow Top Railings & Timber Playtime® Panels

Bow Top has a traditional steel 'hoop' top, pale through rail design and is versatile enough to suit a range of residential or commercial applications.



Bow Top Railings

Playtime® Timber Panel



Timber Playtime® fencing was originally designed for play areas in parks, recreation areas and nursery/primary schools. However, it has also proven to be popular in rural settings as a demarcation or front garden fence. Its appearance is like a very robust version of a palisade or picket fence.

Bow Top Railings

Bow Top is available in two heights of 1.00m and 1.20m and is manufactured from tubular steel, featuring concealed, vandal-proof panel to post fixings, resulting in a seamless design. (Posts are also available with base plates for fixing to concrete).

Single and double leaf matching gates are available, supplied with posts and fittings.

Fence heights: 1.00m & 1.20m (60mm clear of ground)

Posts: 60.3mm diameter circular hollow section

Post centres: 3000mm

Post lengths: 1.50m or 1.80m to allow for 0.50/0.60m in the ground subject to fence height

Pales: Diameter 19mm circular hollow section

Rails: 50mm x 25mm rectangular hollow section

Bow Top Railings

Panel Height	Ref	Price	Post for Panels	Ref
1.00m	071460 ○	P.O.A	1.00m	071402 ○
1.20m	071462 ○	P.O.A	1.20m	071403 ○
Connectors 4 each panel				020000 ○

Bow Top Gates (Self Closing)

Single Gate 0.90m wide			Double Gate 3.0m wide	
Height	Ref	Price	Height	Ref
1.00m	071440BM ○	P.O.A	1.00m	071406 ○
1.20m	071450BM ○	P.O.A	1.20m	071407 ○

Bow Top is galvanised as standard, please ask about coating prices.

Timber Playtime® Fencing

All timber used throughout is superior quality, planed Jakcure® treated softwood and guaranteed for 25 years, while fittings and fixings are of galvanised or stainless steel.

All elements of Timber Playtime® fencing are specifically designed to be inherently safe and conform both to BS EN 1176 play fence standards and RoSPA guidelines.

The design ensures that children cannot get either their necks or limbs trapped between pales or pale tops.

Timber Playtime® fencing is supplied as easy to install panels with gravel boards for attaching to posts and rail connectors. The flexible design will accommodate sloping sites without stepping.

Fence heights: 1.09m (standard) additional heights available

Posts: 125mm x 125mm by 1.80m overall

Post centres: 1775mm or 3255mm

Post lengths: 1.80m to allow for 0.75m in the ground

Pales: 100mm x 38mm (nominal sizes)

Rails: Double paired 100mm x 38mm (nominal sizes)

For more information about both of these products or a quote please 0800 41 43 43.

○ Made to order (cannot be cancelled once ordered)



Optional Additional Feature

We have introduced an additional feature you can add to our classic Bow Top fences, just to add a little extra interest and to give your fence a different look:

Extra pales set between the standard pales, topped off with a finial within the bow (there is a range of different finials to personalise your fence), please ask us for more details.



Bow Top Railings



Timber Playtime



To see our latest prices, view the products above on our website by scanning the QR codes.

EuroGuard® Regular & EuroGuard® Combi

EuroGuard® Regular consists of welded steel wire panels, with a unique reinforced 'V' profile to increase rigidity and strength which are clamped to galvanised steel posts. These panels are ideal for commercial properties, schools, car parks or residential areas.



EuroGuard® Combi

EuroGuard® Combi brings our experience and reputation in steel and timber fencing and gates together in a design that combines the beauty of natural wood with the strength of steel.

EuroGuard® Regular Fencing

EuroGuard® Regular makes for a thoroughly versatile system, a bit out of the ordinary in a residential setting but able to be adapted to the individual needs of most homeowners in urban settings. The mesh panels feature V shaped accents which reinforce structural rigidity and increase its strength.

Height	Post Centres	Post Dimensions	Overall Post Length
1525mm	3034mm	60mm x 40mm	2100mm
1810mm	3034mm	60mm x 40mm	2500mm
2010mm	3034mm	60mm x 40mm	2800mm
2410mm	3054mm	80mm x 40mm	3300mm

Panels widths: 3.00m

Mesh: 200mm x 45mm wire with 3 - 4 reinforcing folds according to panel height

Vertical and horizontal wires: 5mm diameter measured before coating

Posts: Supplied with cap and fittings

EuroGuard® Regular Panels

Height	Width	Ref
1.50m	3.00m	073156 ○
1.80m	3.00m	073157 ○
2.00m	3.00m	073158 ○
2.40m	3.00m	073159 ○

EuroGuard® Posts

Height	Fence Height	Ref
2.10m	1.50m	073067 ○
2.50m	1.80m	073068 ○
2.80m	2.00m	073069 ○
Clip for fixing (3/4 per post)		073163BM ○
Driving tool for screws		073160 ○

For more information about both of these products or a quote please 0800 41 43 43.

○ Made to order (cannot be cancelled once ordered)

EuroGuard Combi



EuroGuard Regular



To see our latest products, view our website by scanning the QR codes.



EuroGuard® Regular

EuroGuard® Combi Fencing

EuroGuard® Combi robust welded mesh fence panels and matching gates also provide additional advantages of a flat facing surface with no hand or foot holds for enhanced security while closely spaced slats add privacy. The Jakcure® treated timber slats are held securely in place by sturdy timber top and bottom rails and the steel posts are timber clad for a finishing touch.

Height	Post Centres	Post Dimensions	Overall Post Length
1585mm	3054mm	80mm x 60mm	2100mm
2070mm	3054mm	80mm x 60mm	2800mm

Panels widths: 3000mm

EuroGuard® Combi Panels (include panels and slats)

Height	Ref
1.58m	747200S ■
2.00m	747250S ■

EuroGuard® Combi Posts (include posts, covers and 6 connects)

Height	Ref
2.00m	748020S ■
2.50m	748025S ■
Fixing tool	073160 ■

EuroGuard® Combi carries our 25-year Service Life Guarantee on steel and 25-year Jakcure® guarantee on timber components. Matching gates are available - price on application.

EuroGuard® Combi panels are supplied in kit form for assembly on site and posts are supplied with cap and fittings.

For more information about both of these products or a quote please 0800 41 43 43.

■ Check for availability

Garden Gates

Our garden gates are made from premium quality timber softwood and come in a range of solid and slatted designs to suit all fence styles and heights.



Due to the erratic price changes in raw material, we have temporarily removed prices from our Good Fencing Guide.

To see our latest prices for our range of garden gates, view our website by scanning the code on the left.

You can choose between a variety of solid gates that offer privacy and security or slatted or woven designs that can help create a light and airy space. You can also choose between a flat top style garden gate or an arched finish - either concave or convex.

Featherboard Gates

Matching our most popular style of fencing, this timeless Featherboard gate creates a solid, simple entrance, available with a curved or flat top.

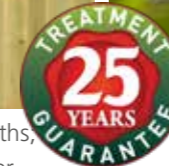

Rearview of gate with optional Brenton Bolt

Featherboard gates are offered in 0.90m and 1.00m widths, wider gates and paired gates are available to special order, please ask for a price and details. Featherboard gates are constructed using Jakcure® treated softwood in a sawn finish and use galvanised bolts and stainless steel nails. Right hand hanging as standard. (Left hand hanging also available). Please note that pairs of convex or concave garden gates will have one curve as standard. This applies to most garden gates not just Featherboard. Stiles are 120mm wide to allow the fitting of optional J-Lock and Latch. Posts for hanging garden gates, see page 48 - 49 unless gate is not in fence run as then we need larger posts.

Our gate posts, like all Jacksons panels and traditional fencing systems, are supplied in natural Jakcure® treated finish and are guaranteed against rot and insect attack for 25 years.

To hang a standard gate up to 0.90m wide, use planed 91mm x 91mm posts. If the standard gate is 0.90m or 1.00m use 125mm x 125mm nominal posts. Slotted end posts (Ref 668500) 2.40m long can be used to hang most standard gates in a fence run. However for certain gate types and non standard sizes you may require taller or larger posts. In this instance, please ask for advice.

The rise and fall on convex and concave Featherboard gates is 75mm. The gate height stated is the maximum height of the gate. We recommend a 50mm gap below the gate for clearance. Adjustable hinges, shutting strips and latch are supplied with every standard gate. They are essential to ensure the gate is held in the correct position to avoid twisting. Gates and latches are always to be operated by an adult. The structure (right) of the gate remains the same for the Concave and Convex styles.

● Stock items ○ Made to order (cannot be cancelled once ordered)

Featherboard Gates (Level Top)				
Gate* Height	Fence Height	Gate Width	Ref	
1.78m	1.80m	0.90m	231900	●
1.18m	1.20m	1.00m	231100	●
1.48m	1.50m	1.00m	231200	●
1.78m	1.80m	1.00m	231300	●
1.93m	1.95m	1.00m	232000	●

*including capping

Concave Featherboard Gates				
Gate* Height	Fence Height	Gate Width	Ref	
1.15m	1.20m	1.00m	231101	○
1.45m	1.50m	1.00m	231211	○
1.75m	1.80m	1.00m	231301	○

Convex Featherboard Gates				
Gate* Height	Fence Height	Gate Width	Ref	
1.15m	1.20m	1.00m	231102	○
1.45m	1.50m	1.00m	231202	○
1.75m	1.80m	1.00m	231302	○

*Convex and Concave gates do not have capping

Advice: We always recommend a 50mm gap below the gate for clearance to avoid leaves building up. Shutting strips and latch are supplied with every gate. They are essential to ensure the gate is held in the correct position to avoid twisting. Stiles are 120mm wide.

Brook & Brabourne Boarded Garden Gates

Robust and versatile, for use with Tongue & Groove Effect Panels, both Brook and Brabourne gates will add privacy to any property.



Supplied in a natural, planed Jakcure® treated finish and constructed using galvanised bolts and stainless steel nails, these gates feature 120mm wide stiles to allow the fitting of optional J-Lock and Latch. Right hand hanging as standard. (Left hand hanging also available). Standard widths: 750mm, 900mm and 1m; wider gates and paired gates are available to special order, please ask for price and details. Standard heights: 1.18m, 1.48m, 1.78m and 1.93m when hung 50mm above the ground for clearance. The capping rail on a Brook gate top matches fence capping rail. Posts for hanging garden gates (see page 48 - 49) unless gate is not in fence run as then we need larger posts.

Special size gates can be made to order subject to size limitations, please ask for a quote and ensure that you allow 10mm each side of the gate for gaps and adjustments.



Gate fittings include heavily galvanised ring latch, adjustable hook and band hinge. The structure (left) of the gate remains the same for the Concave and Convex styles.

Wall Plate, J-Lock & Latch

Please see page 67 for information.

Please note: all standard gates are available in pairs though not displayed in images.

Some timber products will take a while to dry out after the Jakcure® process and natural shrinkage can occur. To prevent unstained timber becoming visible, we recommend not staining products until they have had a prolonged period of dry weather to fully dry out.



Brook Gate (Suited to T&G Panels)

Gate* Height	Fence Height	Gate Width	Ref
1.18m	1.22m	1.00m	275800 ○
1.48m	1.52m	1.00m	275900 ○
1.78m	1.83m	0.75m	276000 ●
1.78m	1.83m	0.90m	276100 ●
1.78m	1.83m	1.00m	276200 ●
1.93m	1.83m**	1.00m	276250 ●

*including capping

**To suit 1.83m panel on Gravel Board



Brabourne Gate (Convex Top)

Gate* Height	Fence Height	Gate Width	Ref
1.15m	1.22m	1.00m	277100 ○
1.45m	1.52m	1.00m	277200 ○
1.75m	1.83m	0.75m	277300 ●
1.75m	1.83m	0.90m	277400 ●
1.75m	1.83m	1.00m	277500 ●

*Convex gates do not have capping

The drop on Convex gates is 75mm. The gate height stated is the maximum height of the gate.

● Stock items ○ Made to order (cannot be cancelled once ordered)

Hit & Miss Gates

Hit and Miss gates are available in vertical and horizontal styles to match our fencing and offer a modern solution for creating an airy garden without compromising on privacy.



Posts for hanging garden gates, see page 48 - 49 unless gate is not in fence run as then they need larger posts. Special size gates can be made to order, please ask for a quote. We can make many of our gates to special sizes, size limitations vary. Please allow 10mm each side of the gate for gaps and adjustments. Gate fittings include ring latch, adjustable hook and band hinges. Fittings are heavily galvanised steel.



Hit & Miss Gates Vertical

Gate* Height	Gate Width	Ref**
1.93m		
Right handed	1.00m	631920 ○
Left handed	1.00m	631922 ○

Gate* Height 1.78m

Right handed	1.00m	631900 ●
Left handed	1.00m	631990 ●

Hit & Miss Gates Horizontal



Gate* Height	Gate Width	Ref**
1.93m		
Right handed	1.00m	631820 ○
Left handed	1.00m	631822 ○

Gate* Height 1.78m

Right handed	1.00m	631800 ●
Left handed	1.00m	631880 ●

*both options including capping. **1.78m are stock - 1.93m are not.
Hit & Miss gates now have 120mm stiles to allow fitting of key locks. ● Stock items
■ Check for availability ○ Made to order (cannot be cancelled once ordered)



Wall Plates

Wall Plates for fixing gates to walls. A wall plate is a length of timber that can be fixed to a wall that the gate can then be hung on. Planed finish dimensions before treatment.

Height	Size	Ref
1.80m planed finish	95mm x 70mm	228000 ●
2.10m planed finish	95mm x 70mm	228050 ■
2.40m planed finish	95mm x 70mm	228100 ■
1.80m planed finish	95mm x 45mm	171000 ●
2.10m planed finish	95mm x 45mm	171021 ■
2.40m planed finish	95mm x 45mm	171024 ■



J-Lock and Latch*

The perfect solution for our Courtyard and timber garden gates. Stainless steel 60mm back-set mortice lock and latch for single and double leaf timber gates. The adjustable self-latching bolt in combination with the stainless steel hook (dead bolt) provides extra security.

	Ref
J-Lock fitted	357700BM ○
J-Lock supply only	357770BM ■

*Can be fitted to a gate with 120mm stiles. Other gates with 95mm stiles can be supplied with a heavier frame as a special order, if a lock is required.

Venetian Hit & Miss, Urban Gates & Horizontal Tongue & Groove Gates

These slatted style gates are new to our range and have been designed for all types of garden, from contemporary settings to rural locations, offering an attractive entrance to any property.



Venetian Hit & Miss must be hung on 150mm x 150mm posts

Urban

For posts for hanging garden gates, see page 48 - 49. Special size gates can be made to order, please ask for a quote. We can make many of our gates to special sizes, size limitations vary. Please allow 10mm each side of the gate for standard gaps and adjustments.

Gate fittings include ring latch, adjustable hook and band hinges. Fittings are heavily galvanised steel.

Venetian Hit & Miss Gates			
Gate* Height	To Suit Fence Height	Gate Width	Ref (inc fittings)
1.915m			
Right handed	1.970m	1.00m	657810BM ○
Left handed	1.970m	1.00m	657811BM ○

Urban Gates			
Gate* Height	To Suit Fence Height	Gate Width	Ref
1.93m			
Right handed	2m	1.00m	658500 ○
Left handed	2m	1.00m	658550 ○

*including capping

*including capping
 ● Stock items ■ Check for availability ○ Made to order (cannot be cancelled once ordered)

Gate Instructions

Need help measuring for a garden gate?

We offer installation instructions and advice for how to measure garden gates on our website, or give our friendly sales team a call for further advice.

Visit: www.jacksons-fencing.co.uk/gates

Horizontal Tongue & Groove Gates			
Gate* Height	To Suit Fence Height	Gate Width	Ref
1.78m			
Right handed	1.8m	1.00m	277600 ○
Left handed	1.8m	1.00m	277660 ○

*including capping



Due to the erratic price changes in raw material, we have temporarily removed prices from our Good Fencing Guide.

To see our latest prices for our range of garden gates, view our website by scanning the code on the left.

Venetian, Chilham, Woven & Canterbury Combi Gates

Our slatted and solid gates are designed for all types of garden, from rural to urban, offering an attractive entrance to any property.



For posts for hanging garden gates, see page 48 - 49. Special size gates can be made to order, please ask for a quote.

We can make many of our gates to special sizes, size limitations vary. Please allow 10mm each side of the gate for standard gaps and adjustments.

Gate fittings include ring latch, adjustable hook and band hinges. Fittings are heavily galvanised steel.

Chilham Gates			
Must only be used with 'L' hinges supplied			
Gate* Height	To Suit Fence Height	Gate Width	Ref
1.78m			
Right handed	1.8m	1.00m	656400 ●
Left handed	1.8m	1.00m	656440 ●

*plus capping.

Venetian Gates			
Gate* Height	To Suit Fence Height	Gate Width	Ref
1.78m			
Right handed	1.83m	1.00m	657700 ●
Left handed	1.83m	1.00m	657770 ●

*plus capping

Woven Gates			
Must only be used with 'L' hinges supplied			
Gate* Height	To Suit Fence Height	Gate Width	Ref
1.78m			
Right handed	1.83m	1.00m	656610 ○
Left handed	1.83m	1.00m	656611 ○

*including capping

Canterbury Combi Gates			
Gate* Height	To Suit Fence Height	Gate Width	Ref
1.93m			
Right handed	2m	1.00m	659100 ○
Left handed	2m	1.00m	659110 ○

*plus capping.

● Stock items ○ Made to order (cannot be cancelled once ordered)

Palisade & Jaktop Gates

Palisade gates are available with pointed or rounded tops and are perfect for creating an attractive entrance to front gardens and pet enclosures. Our unique Jaktop gates are perfect for cottage gardens and front entrances, combining strength with unique style to create an attractive entry to your property.



For posts for hanging garden gates, see page 48 - 49.
For Mitre gate specification please see page 26 - 27.
Special size gates can be made to order, please ask for a quote. We can make many of our gates to special sizes, size limitations vary. Please allow 10mm each side of the gate for standard gaps and adjustments.

Gate fittings include ring latch, adjustable hook and band hinges. Fittings are heavily galvanised steel.



Palisade Gates Rounded Pale Tops

Gate Height	To Suit Fence Height	Gate Width	Ref
1.78m			
0.95m	1.00m	1.00m	223300 ●
1.15m	1.20m	1.00m	224300 ●
1.75m	1.80m	1.00m	225800 ■



Palisade Gates Pointed Pale Tops

Gate Height	To Suit Fence Height	Gate Width	Ref
1.78m			
0.95m	1.0m	1.00m	222700 ●
1.15m	1.20m	1.00m	222600 ●
1.75m	1.80m	1.00m	225900 ○

● Stock items ■ Check for availability ○ Made to order (cannot be cancelled once ordered)



Jaktop Gate

Gate Height	Fence Height	Gate Width	Ref
0.86m	0.90m	1.00m	602600 ○
1.15m	1.20m	1.00m	602900 ○
0.86m	0.90m	1.20m	602700 ○
1.15m	1.20m	1.20m	603000 ○
0.86m	0.90m	1.50m	602800 ○
1.15m	1.20m	1.50m	603100 ○
Centre Gate Stop			602200 ■

Palisade Gate Posts

1.50m & 1.80m are 100mm x 75mm & 2.40m (nominal) are 125mm x 75mm section* (not morticed).

Gate Height	Post height	Rounded Tops Ref	Pointed Tops Ref
0.95m	1.50m	223400 ●	220500 ●
1.17m	1.80m	224400 ●	220600 ■
1.75m	2.40m	226800 ■	226500 ○

*If digging into soft ground, it may be necessary to upgrade to a 1.80m post for a 0.95m gate.

Square Top Standard & Premier Trellis Gates

Ideal for confined spaces, dark corners or used within a garden to separate areas, trellis gates offer an attractive access solution that increases light.



Imageshowsbespoke 1.98m trellis gate

Imageshowsbespoke 1.98m trellis gate

For posts for hanging garden gates, see page 48 - 49.
Special size gates can be made to order, please ask for a quote. We can make many of our gates to special sizes, size limitations vary. Please allow 10mm each side of the gate for standard gaps and adjustments.

Gate fittings include ring latch, adjustable hook and band hinges. Fittings are heavily galvanised steel.

Wall Plate, J-Lock & Latch

Please see page 67 for information.

Jakcure® Cut Treatment

Where cutting or drilling treated timber cannot be avoided, always use Jakcure® Cut Treatment to ensure no timber is left untreated and the conditions of the 25-year Jakcure® guarantee are met. Read the instructions carefully.



	Ref
500g bottle	131212 ●

● Stock items ○ Made to order (cannot be cancelled once ordered)



Square Top Standard Trellis Gates

Must only be used with 'L' hinges supplied

Gate* Height	To Suit Fence Height	Gate Width	Ref
1.78m			
Right handed	1.83m	1.00m	639500 ○
Left handed	1.83m	1.00m	639550 ○

*including capping



Premier Trellis Gates (Right Handed)

Gate* Height	To Suit Fence Height	Gate Width	Ref
1.78m			
100mm Square	1.83m	1.00m	740000 ○
Lattice	1.83m	1.00m	750000 ○
Diamond	1.83m	1.00m	744000 ○

*including capping. Finals & post caps are on page 52 - 53.



To see our latest prices for Trellis garden gates, view our product name page on our website by scanning the QR code.

Pergola Systems

Our Pergola systems are designed to be highly versatile, allowing you to create single or double structures to suit your project.



Pergolas are a great way to create distinct areas within your outside space, for instance separating patios, creating extra privacy for dining, or social areas.



Some favour double Pergolas to frame seating areas or pathways.

You can create different looks, atmospheres or styles by adding Trellis infill panels or semi-solid fencing.

Our Diamond Premier Trellis will let more air and light through, it has a traditional feel and actively encourages climbing plants, while Lattice panels with a much smaller square, allow less light through, but are better for privacy.

Double Pergolas can give you something more than an attractive or decorative screen. Instead of a single run of posts and small cross members on the top with your choice of infill panel, with a double Pergola you get to add greater depth.

Using a minimum of two runs of posts you can install a long cross member across the top, which is repeated at set intervals. As you can see in the photo (top), this creates a simple structure.

The double Pergola flanks a walkway, making a feature of a path or even a terrace. Once climbers have established, a tunnel of dappled light will be created, revealing or framing vistas within your garden.

Corner Pergola (opposite) is made from two Trellis panels, posts and the Pergola parts pictured in the photo. Full pergolas consist of three trellis panels. It is also available without the panel on the left as a two panel corner.

The standard length of bays is 1.83m as measured between the posts, this allows for non-standard height fence panels to be used with our Pergola systems. This means you can increase the length of the Pergola in multiples of 1.83m. The cross members overhang the structure by 200mm. We recommend that the Pergola is installed so that the underside of the side rails is 2.00m above ground level.



Quality product at a sensible price. Really pleased with the beautiful quality of timber for our Double Pergola. Perfectly finished & ready to easily assemble. Two people & just a few hours to be built into decking... including re charging & changing batteries for tools. Very good online diagrams & instructions. Will definitely recommend & use in the future. The staff on the phone were very helpful & helped us decide exactly what we needed before we ordered. Delivery was superb too.

Diane Clinch, December 2019.



To see our latest prices, view our Pergolas on our website by scanning the QR code





75mm nails (800210 - 1kg) are used for the majority of the construction, but you should use 100mm nails (800310 - 1kg) for the in-line braces. When using nails to join two timber parts we recommend drilling a pilot hole through the first part to insert the nail through, this enables the nail to be driven easily into the other part of the structure, and reduces the likelihood of splitting.

Let us help you design your Pergola or answer any questions. Our specialist advisors are always happy to assist to make sure you get the best possible solution. Instructions for installation of most of our products are available from our website. Alternatively we can send you a hard copy on request.

Single Pergola Components

Description	Ref
(H) Post 91mm x 91mm	641600 ●
(A) Short Cross Member 0.57m	650100 ■
(K) Mid Side Rail 1.92m	650300 ■
(L) End Side Rail 2.174m	650310 ■
(M) Double Ended Side rail 2.42m	650320 ■
(F) In Line Brace 0.50m	650400 ■
(D) Spacer Block	650700 ■
(J) Post Top	650750 ■

Single Pergola Price Calculator

Description	Ref
One bay only	PSSB
Two bays (a first and end bay)	PSFB and PSEB
Three bays	PSFB, PSAB and PSEB
Extra bays add	PSAB for each additional 1.83m

Corner Pergola Standard Kit

Description (all dims in mm)	Ref
x3 panels (2355 x 2247 x 4168)	656900BM ○
x2 panels (2355 x 2247 x 2247)	656990BM ○

Corner Pergola standard kits including two or three panels, posts, cross members etc. with instructions. Fixings are not included with the corner Pergola, we would suggest the 'pergola fixing pack' is also purchased - Stock code: 'PERGOLA'

Jakcure® Cut Treatment

Description	Ref
500g bottle	131212 ●

● Stock items ■ Check for availability

SINGLE PERGOLA (shown with two bays)

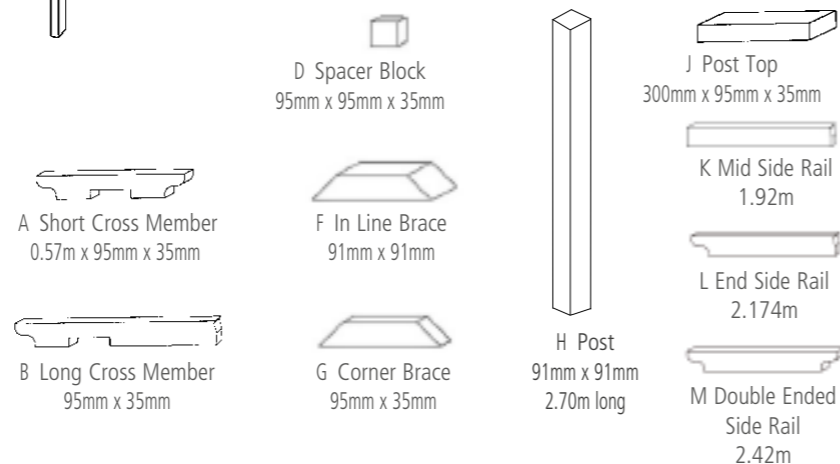
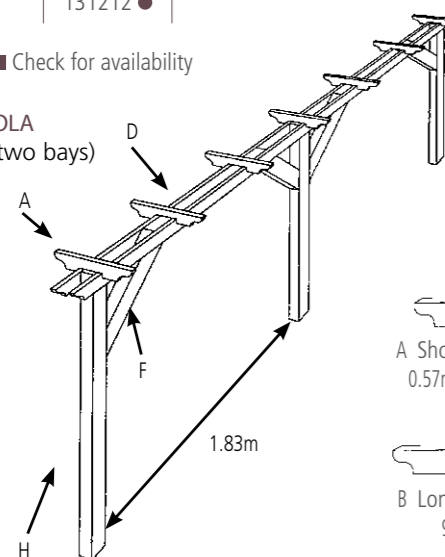

DOUBLE PERGOLA (shown with two bays)

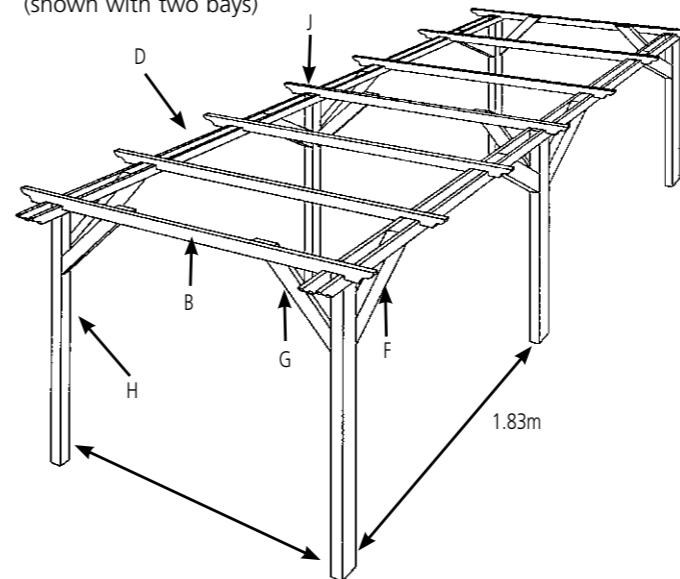

Double Pergola Components

Description	Ref
(H) Post 91mm x 91mm	641600 ●
(B) Long Cross Member 1.80m	650200 ■
(B) Long Cross Member 2.10m	650800 ■
(B) Long Cross Member 2.40m	650900 ■
(B) Long Cross Member 2.70m	651000 ■
(K) Mid Side Rail 1.92m	650300 ■
(L) End Side Rail 2.174m	650310 ■
(M) Double Ended Side Rail 2.42m	650320 ■
(F) In Line Brace 0.5m	650400 ■
(G) Corner Brace 590mm	650500 ■
(D) Spacer Block	650700 ■
(J) Post Top	650750 ■

Double Pergola Price Calculator

Width	1 Bay / Fixings		2 Bays		3 Bays	
	Type	Ref	Type	Ref	Type	Ref
1.80m	One Bay	PDSB1.8	First Bay	PDFB1.8	First Bay	PDFB1.8
			End Bay	PDEB1.8	Additional Bay	PDAB1.8
	Fixing Pack	PERGOLA	-	-	End Bay	PDEB1.8
2.10m	One Bay	PDSB2.1	First Bay	PDFB2.1	First Bay	PDFB2.1
			End Bay	PDEB2.1	Additional Bay	PDAB2.1
	Fixing Pack	PERGOLA	-	-	End Bay	PDEB2.1
2.40m	One Bay	PDSB2.4	First Bay	PDFB2.4	First Bay	PDFB2.4
			End Bay	PDEB2.4	Additional Bay	PDAB2.4
	Fixing Pack	PERGOLA	-	-	End Bay	PDEB2.4
2.70m	One Bay	PDSB2.7	First Bay	PDFB2.7	First Bay	PDFB2.7
			End Bay	PDEB2.7	Additional Bay	PDAB2.7
	Fixing Pack	PERGOLA	-	-	End Bay	PDEB2.7

● Stock items ■ Check for availability ○ Made to order (cannot be cancelled) once ordered

Premier Trellis

Premier Trellis, as the name suggests, is our premium Trellis range. We offer many panel sizes and three different infill patterns to choose from; Diamond, Square and Lattice.



All Premier Trellis panels feature a strong planed timber frame, designed for use with slotted Jakposts, so they can fit perfectly on top of a panel as a Trellis topper panel.



Inspirational

If you have any photos of our products in your garden projects we'd love to see them, please email: pics@jacksons-fencing.co.uk

Used alone they are great for creating enclosures, screens and decorative structures in your garden.

A very traditional use for Trellis has been to attach it to walls to encourage climbing plants to twine around.

All timber used throughout is superior quality Jakcure® treated softwood, guaranteed for 25 years, with a planed finish. The timber framing is 45mm x 51mm with battens generally of 25mm x 12mm. All fixings are stainless steel.

Far top right, shows Lattice Premier panels installed above a brick wall, with a pair of wing Lattice panels at the gateway. Shown top left are Lattice panels installed to provide a high screen above existing fencing. Opposite is Diamond trellis

You can find details on the Premier Trellis panels range in the pages that follow.

Curved Framed Trellis Panel (38mm wide battens)

Description	Ref
1.83m x 300mm high	745300 ○

○ Made to order (cannot be cancelled once ordered)



To see our latest prices, view our Trellis on our website by scanning the QR code





Premier Trellis is handmade from quality planed finish Jakcure® treated softwood and guaranteed for 25 years. Choose the sizes you want to make any combination of base panels, topper panels and wing panels. See the previous page for examples of other customers' trellis ideas. For Jakposts and decorative post caps see pages 48 - 49. Matching gates for the Trellis panels are available, see garden gate section.

Premier Square Trellis Panels

(100mm squares)
Panel framing is 45mm x 51mm with 25mm x 12mm battens.
Available in the sizes below:

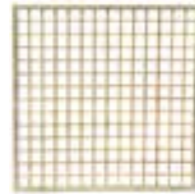

Height	Width	Ref
300mm	1.83m	740100 ●
430mm	1.83m	740200 ○
560mm	1.83m	740300 ●
810mm	1.83m	740500 ○
940mm	1.83m	740600 ○
1190mm	1.83m	740800 ○
1320mm	1.83m	740900 ○
1450mm	1.83m	741000 ○
1570mm	1.83m	741100 ○
1830mm	1.83m	741300 ●

Trellis Wing Panel

(100mm squares)
Size: 560mm x 940mm
sold as singles or in pairs.



Description	Ref
Pair	744000BM ○
Left hand single panel	744010 ○
Right hand single panel	744020 ○

● Stock items ○ Made to order (cannot be cancelled once ordered)

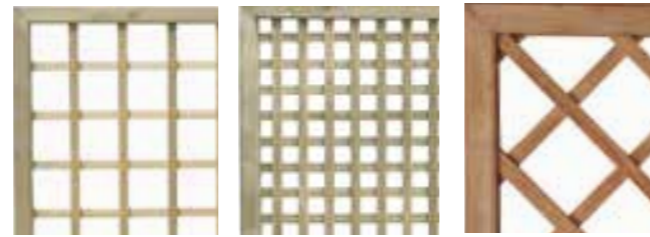

Lattice Trellis Panels

(38mm squares)
Panel framing is 45mm x 51mm with 25mm x 12mm battens.
Available in the sizes below:



Height	Width	Ref
300mm	1.83m	750100 ●
430mm	1.83m	750200 ○
560mm	1.83m	750300 ○
810mm	1.83m	750500 ○
940mm	1.83m	750600 ○
1190mm	1.83m	750800 ○
1320mm	1.83m	750900 ○
1450mm	1.83m	751000 ○
1570mm	1.83m	751100 ○
1830mm	1.83m	751300 ●

Lattice Wing Panel

(38mm squares)
Size: 560mm x 940mm
sold as singles or in pairs.



Description	Ref
Pair	775000BM ○
Left hand single panel	775010 ○
Right hand single panel	775020 ○

Diamond Trellis Panels

(100mm diamonds)
(100mm diamonds) Panel framing is 45mm x 51mm with 25mm x 12mm battens.
Available in the sizes below:



Height	Width	Ref
300mm	1.83m	742500 ○
430mm	1.83m	742600 ○
560mm	1.83m	742700 ○
940mm	1.83m	743000 ○
1190mm	1.83m	743100 ○
1450mm	1.83m	743300 ○
1830mm	1.83m	743700 ●

Panel width cut down kits are available for all Premier Trellis panels, please ask or see website.

Roman Topper Panel



Description	Ref
1830mm x 330mm at ends Pale spacings: 16mm x 45mm spaced every 75mm (30mm gaps)	657010

Concave Topper Panel

(100mm squares)
Description
1830mm x 430mm at centre
560mm at ends



Convex Topper Panel

(100mm squares)
Description
1830mm x 560mm at centre
430mm at the ends.



Standard Trellis Range

The Standard Trellis range is our basic trellis system because of its lower cost simple design and non-framed design; it was Jacksons original trellis before we developed our Premier range.

Specification: Made from 25mm x 19mm Jakcure® treated softwood timber infill at 138mm centres with 38mm x 19mm Jakcure® softwood side battens and 45mm x 51mm top rail. All panels are 1.83m wide.

Standard Square Trellis

1.83m wide with nominal 138mm infill centre squares.

Panel Height	Hole	Ref
0.86m	5	638200 ■
1.18m	7	638300 ■
1.50m	9	638400 ■
1.83m	11	638500 ■

Standard Square Topper Panels

Special heights for use as topping above panel fences that are not Standard Trellis.

Panel Height	Hole	Ref
0.30m	2	638700 ●
0.60m	4	638100 ●

Standard Square Trellis Gate

1.00m wide x 1.83m high (see garden gates section) complete with galvanised fittings (Ref 639500).

Metal Trellis

This elegant solution for growing climbers, is a simple metal trellis, rather than the traditional timber design.

Made from galvanised metal, our mesh is polyester powder coated black, and is firmly fixed to the wall with simple fixings, (see below) to hold the trellis an ideal distance from the wall and allow plants to climb and thrive (as you can see in the picture). Fixings sold separately.

Description	Ref
2.00m x 700mm	957070 ■
Fixings (6 required)	816000BM ■



Specification:
Trellis 2.00m high x 700mm wide.
Galvanised and polyester powder coated black. size of hole for fixing the bracket to a wall is M5 x 25 coach screw.

Tartan Trellis Panels

A refreshing spin on traditional Trellis, the attractive Tartan Trellis panel offers a mid-way point between our Premier Lattice Trellis, which provides more screening with its small squares and the larger more open squares of the Premier Square Trellis.



By placing the pales at irregular spacings, we have given our trellis range a new look and the effect is an unusual pattern rather reminiscent of plaid or tartan.



Tartan Trellis panels make a perfect airy screen in the garden allowing light to pass through easily. When the sun shines through it creates unusual and striking shadows. As with all our timber products, Tartan Trellis panels are manufactured from Jakcure® pressure treated timber that's guaranteed for 25 years and designed for use with slotted Jakposts, gravel boards and capping rails or post caps, see pages 48 - 49. Due to its symmetrical design, the Tartan Trellis panel is only available at 1.83m wide x 1.83m high.

Specification: Panel framing is 45mm x 51mm for extra strength. Battens are 25mm x 12mm. All fixings are stainless steel.

To meet the conditions of the 25-year Jakcure® guarantee, gravel boards are required where panels are in contact with the ground, see pages 50 - 51.

Tartan Trellis Panels (1.83m wide)

Height	Ref	Cut width kit	
		Height	Ref
1.83m	752300 ○	1.83m	741300K ●

If you have to cut down a panel on site then use the above kit reference. Always use Jakcure® End Grain Treatment on cut timber, see page 53.

● Stock items



Did You Know:

There is no need to apply any further timber protection treatment to your Jacksons Jakcure® treated product. Some customers might want to add colour to their products. In these cases, please be aware that timber will naturally take a while to dry, during which, natural shrinkage can occur, so we recommend that you don't apply any colour coatings until the timber is fully dry and stable.



To see our latest prices, view our Tartan Trellis on our website by scanning the QR code



Landscape Timbers, Jakwall® & Sleepers

Jakwall is a distinctive grooved, brick effect landscape timber system, unique to Jacksons Fencing.



Ungrooved



Grooved 140mm

It can be used to create retaining walls and is perfect for raised borders, fish ponds, play areas, sand pits or fascia borders.



Sleepers



Jakwall® has four options: 1. 90mm grooved face towards the front, ideal for creating retaining walls or raised flower beds. 2. Grooved all round, so every face shows the brick effect grooves. 3. 140mm grooved face to the front, this larger 'brick' effect front is more suitable for creating a timber wall or barrier. 4. No grooves but with smooth edges.

Installing Jakwall® can work out considerably cheaper than traditional bricks and mortar. It has a simple and easy installation method using timber screws that fix the timbers together without the need for pre-drilling. Always use Jakcure® End Grain Treatment on cut timber - page 53.

Ungrooved or plain Jakwall® was introduced in response to requests from landscape gardeners who loved the Jakwall landscape timber system but preferred a simpler effect.

Jakwall

Description	Ref
2.35m x 140mm x 90mm grooved on 90mm face	171700 ○
2.35m x 140mm x 90mm grooved on one 140mm face	171801 ●
2.35m x 140mm x 90mm grooved all round face	171900 ○
2.35m x 140mm x 90mm not grooved	171910 ●

Sleepers

Description	Ref
We also offer sawn timber sleepers for landscaping projects. These are ideal for raised beds and decorative structures. 2.40m long 200mm x 100mm	171500 ■

Fixings

Description	Ref
100mm fixing timber screw for hex head	171709 ●
150mm fixing timber screw for hex head	171710 ●
200mm fixing timber screw for hex head	171810 ●
250mm fixing timber screw for hex head	171811 ●
Hex bit for 5/16" for timber screws	171720 ●

● Stock items ■ Check for availability ○ Made to order



Seamless high quality service, advice and product. Thank you to Kelly (sales) and Andy (delivery) for excellent customer care. Would not hesitate to recommend on all levels.
Ray Cranston, November 2019.



Sleepers



Jakwall



Please scan the QR code using your device for product you would like to see pricing for.

Decking & Balustrade

As more of us are spending our leisure time outdoors, where better to enjoy an informal meal with friends and family than on the deck? It is the perfect solution for sloping sites or terracing, and it's a great way of joining the house to the garden.



All Jacksons' decking boards are grooved to aid slip resistance and made from premium quality Jakcure® treated softwood, guaranteed for 25 years. There are three board types available - Standard or Heavy Duty and slip resistant Heavy Duty.

To see our latest prices, view our Decking & Balustrade on our website by scanning the QR code



Detail of decking board profile showing the grooves on top surface and the stress relief cuts on the bottom surface of boards to help avoid warping as boards expand and contract with the weather conditions.

Decks are constructed with spaces between boards to aid drainage and to allow for the natural expansion and shrinkage of the timber, while all fixings and fastenings are non-rusting to ensure an extra-long life.

Decking Boards & Fixings

Description	Ref
Heavy decking board 3.00m x 150 x 32mm (nominal)	755901 ■
Heavy decking board 3.60m x 150 x 32mm (nominal)	755900 ■
Slip Resistant decking board 3.60m x 150 x 32mm	755900SR ■
Heavy decking board 4.20m x 150 x 32mm (nominal)	755902 ■
Heavy decking board 4.80m x 150 x 32mm (nominal)	755910 ■
Standard decking board 3.60m x 100 x 25mm (nominal)	755600 ●
Standard decking board 4.20m x 100 x 25mm (nominal)	755610 ■
Decking joist 3.00m x 100mm x 50mm (thickened)	755100 ●
Decking joist 3.60m x 100mm x 50mm (thickened)	755200 ●
Decking joist 3.60m x 150mm x 50mm (thickened)	755220 ●
Decking support post 0.60m x 100mm diameter	755300 ■
Decking support post 0.90m x 100mm diameter	755400 ■
Decking support post 1.20m x 100mm diameter	755500 ■
60mm stainless steel screw T25 torx drive - 200 plus driver bit	809902 ●
60mm stainless steel screw T25 torx drive - 500 plus driver bit	809905 ●
Stainless steel self drilling screws 60mm x 5mm / box 200	809900 ●
2 tread decking stringer (850mm long)	759200 ■
3 tread decking stringer (1200mm long)	759300 ■
4 tread decking stringer (1530mm long)	759400 ■
5 tread decking stringer (1865mm long) (Please note that stringers should be placed at 450mm centres)	759500 ■
Weed Control Roll 12m roll x 1.00m wide	755777 ■
Weed Control Sheeting 50m roll x 1.00m wide	755770 ■

● Stock items ■ Check for availability



Ordered my decking online very easily. Especially good and invaluable was the use of the decking calculator. Jacksons kept in touch regarding delivery and delivered on time on the appointed day. Even had a forklift truck and placed the pallets exactly where I wanted. Great decking materials to boot. Would recommend if you want good quality decking

Steve, October 2019.





Specification: 3.6m long boards and planed from 150 x 32mm section boards to give a nominal finished size of 143mm x 28mm. Slip resistant boards.



Balustrade Style 1



Balustrade Style 2

All timber decking is likely to become slippery when wet or in situations where standing water is present. While our decking boards feature deep grooves to disperse water, you should exercise caution when the surface is wet. Periodic cleaning to remove moss and lichen will reduce the risk of slipping. Alternatively, slip resistant decking boards are an option. Be aware that during the natural weathering process boards can occasionally splinter slightly so we recommend not to walk on the deck without footwear.

Slip Resistant Decking Boards

Slip-resistant boards are made from premium quality Jakcure® treated softwood and guaranteed for 25 years. They feature grooves and two additional non-slip grit strips per board, which means when the boards get wet, the grit sections provide added grip. Please be aware that the grit strip does sit slightly above the level of the decking to allow for extra grip, so if someone was to fall on these boards there could be a risk of grazing.

Description	Ref
3.60m Slip Resistant Decking Boards	755900SR ■

■ Check for availability



Steps up to a hot tub constructed from decking boards plus stringer underneath.



Balustrade

Balustrade is available in two styles and is supplied pre-assembled, in a natural Jakcure® treated finish (unpainted).

Style 1: Pre-assembled garden balustrade panel system that gives a nominal finished height of 1.10m, and 1.83m wide. The nominal vertical 75mm x 20mm pales are set at 100mm apart; fitted with 2 pairs of 75mm x 20mm horizontal rails which fit each side of the pales and fixed into position with timber dowels. These panels, as well as being stylish, are ideal for going up slopes, as they rake to suit virtually any angle of incline.

Style 2: This system features pre-assembled panels with turned vertical 40mm x 40mm spindles set at 100mm apart; fitted between 2 horizontal 70mm x 51mm rails planed.

All systems are fitted in Jakposts, either 1.06m high for normal balustrade, or 2.10m if a pergola is to be installed above the deck. The posts are fitted into 100mm x 100mm galvanised and polyester powder coated black shoes (756000) for inter posts and (756010) for end/corner posts onto a base board which is bolted through the deck. In addition, a capping rail (756800) 3.90m long x 120mm x 20mm is available and should always be used on Style 1 system, and is optional for Style 2 system.

Balustrade Style 1

Overall Height 1.10m / Pales 1.06m high

Description	Ref
1.83m wide panel	757300 ■

Post infill piece (planed)

2.00m x 53mm x 24mm	756350 ●
Capping rail 2.40m x 60mm x 17mm	756810 ■
Capping & base board 3.90m x 120mm x 20mm	756800 ●

Balustrade Gates - 1.00m wide

Style 1 right handed	757900 ○
Style 1 left handed	757990 ○
Style 2 right handed	758900 ○
Style 2 left handed	758990 ○

Balustrade Style 2 Spindles 1.10m overall height

1.06m high x 1.83m wide panel Panels can be cut down on site, if smaller widths are required.	758300 ■
--	----------

Gates opening inwards, fittings included.

● Stock items ■ Check for availability

○ Made to order (cannot be cancelled once ordered)



Posts, Galvanised Shoes, Capping & Base Boards

Description	Ref
1060mm intermediate Jakpost	756200 ●
1060mm corner Jakpost	756300 ●
1060mm end Jakpost	756100 ●
Note: use with 3.90m capping rail base board	-

Post for Pergola topping

2100mm Intermediate post	667400 ■
2100mm corner post	667440 ■
2100mm end post	668400 ■

Powder coated galvanised shoe & base plate for Inter (+ screws)	756000 ●
---	----------

Powder coated galvanised shoe & base plate for end/corner (+ screws)	756010 ●
--	----------

3.90m 120 x 21mm capping & base board	756800 ●
---------------------------------------	----------

1.50m long decking spur post & packer	756310 ■
---------------------------------------	----------

We reserve the right to alter specifications in accordance with our policy of continuous improvement.

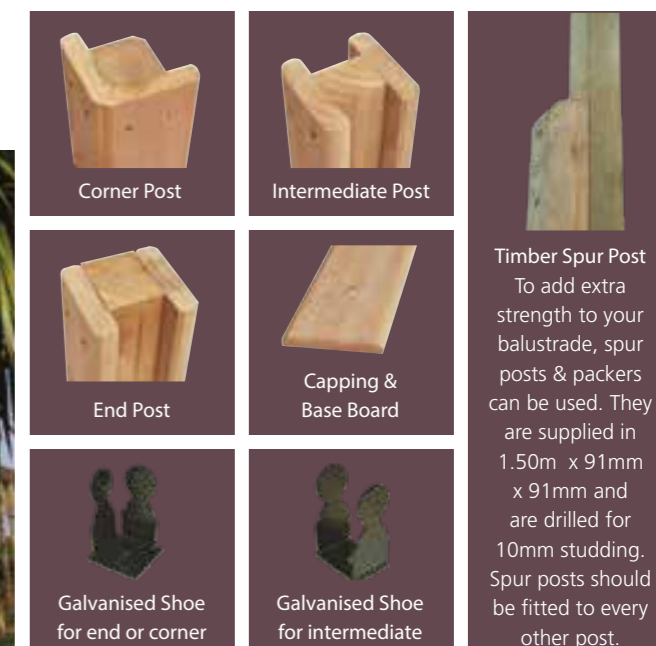

Timber Spur Post
To add extra strength to your balustrade, spur posts & packers can be used. They are supplied in 1.50m x 91mm x 91mm and are drilled for 10mm studding. Spur posts should be fitted to every other post.



Jak-Deck Kits

Here is a quick and easy way to create a deck wherever you want one. Jak-Deck kits are available in three sizes: 1.80m x 1.80m, 1.80m x 3.60m and 3.60m x 3.60m.

Jak-Decks can be assembled easily and used on their own or joined together to create a configuration that suits your project.

All our decking boards are Jakcure® treated, which means they are protected from rot and insect attack for 25 years. Another benefit is our boards are grooved, reducing the risk of slipping.

Please note: Jak-Decks must be fully supported on padstones, compacted gravel or some other firm well-draining surface. All timber decking is likely to become slippery when wet or in situations where standing water is present. You should exercise caution when the surface is wet. Periodic cleaning to remove moss and lichen will reduce the risk of slipping, or alternatively consider slip resistant boards.

Jakcure® Cut Treatment

Where cutting or drilling after treatment cannot be avoided use Jakcure® Cut Treatment to ensure no timber is left untreated. 500g bottle.

Ref
131212 ●

Jak-Deck Kits

1.80m x 1.80m	755001BM ■
1.80m x 3.60m	755000BM ■
3.60m x 3.60m	755002BM ■

● Stock items ■ Check for availability

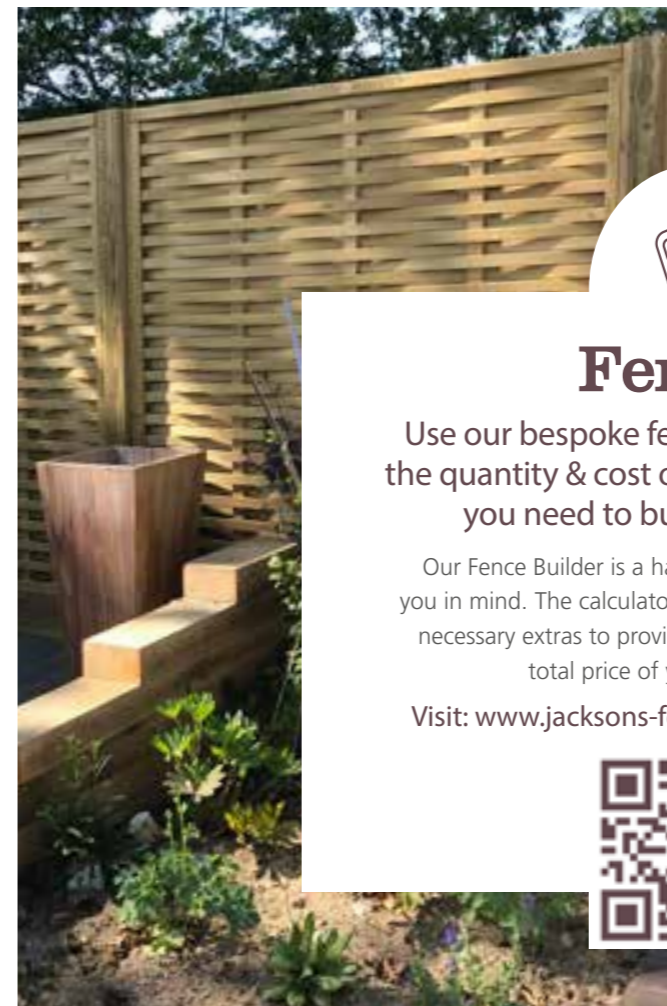

Fencing

Use our bespoke fence builder to calculate the quantity & cost of individual components you need to build your new fence.

Our Fence Builder is a handy application designed with you in mind. The calculator prices each panel, post and any necessary extras to provide an accurate estimate for the total price of your fencing project.

Visit: www.jacksons-fencing.co.uk/fence-builder

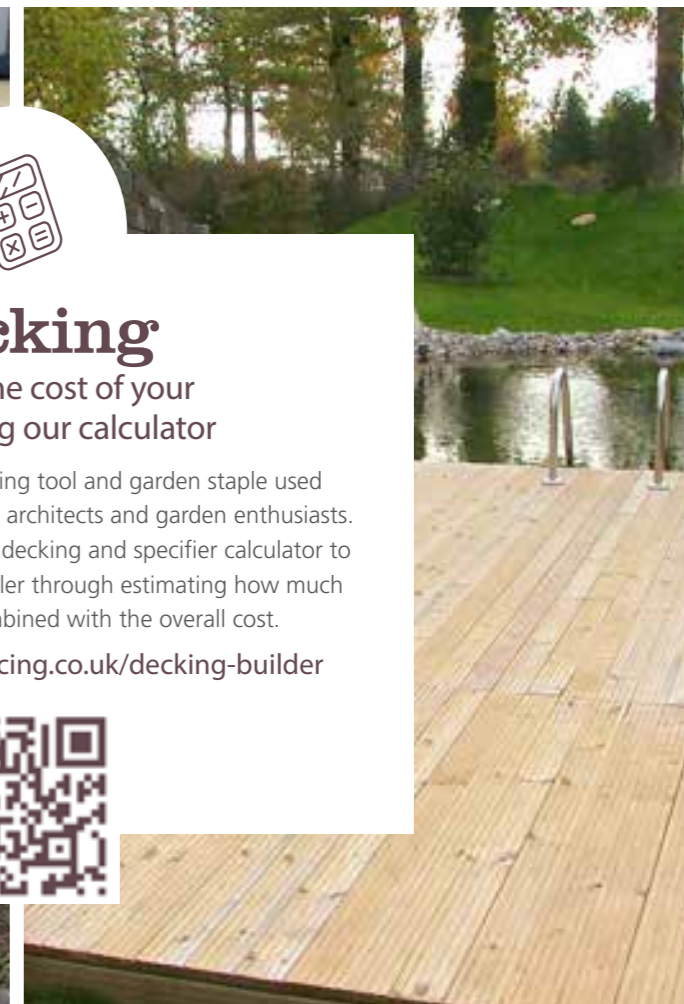

Decking

Calculate the cost of your decking using our calculator

Decking is an ideal landscaping tool and garden staple used by garden designers, landscape architects and garden enthusiasts. We have developed our handy decking and specifier calculator to make the buying process simpler through estimating how much decking you'll need combined with the overall cost.

Visit: www.jacksons-fencing.co.uk/decking-builder



Venetian Retreat

Designed using our popular handcrafted Venetian panels for the sides and roof, the Venetian Retreat Shelter is a unique garden structure that will create a delightful 'retreat' in any garden.



The Venetian panels give the shelter an attractive contemporary design and when the sun is shining, cast dramatic patterns of light and shade.



The standard Retreat is a single unit version, as shown above. If desired, an extra panel can be added at the open side. Wider versions of the Retreat can be achieved by adding a third bay (one extra panel).

The Retreat is available with or without a polycarbonate roof covering. The polycarbonate panel sits on top of the Venetian roof panels with the rear edges protruding over the rear fascia to allow rain water to run off, and the polycarbonate box section channels running in line with the pales, across the roof. (Please note if you select the polycarbonate roof option the roof sheet may be delivered separately from the main timber delivery and can only be delivered in mainland UK).

Specifications: Constructed from Jakcure® treated softwood. Retreat is approximately 2100mm high at the front, 2000mm high at the back.

1676mm from front post to rear post, (1923mm including roof overhang). 3325mm wide. We advise always digging the posts 600mm in the ground.

Instructions for installation of most of our products are available from our website. Alternatively we can send you a hard copy. Please enquire with our sales team.

Venetian Retreat

Description	Ref
Retreat shelter without polycarbonate roof covering	655700BM ○
Retreat shelter with polycarbonate roof covering	655710BM ○
Gutter kit for optional roof sheet (including gutter and downpipe)	673007BM ○
Additional side panel (to fill the right hand-side)	655700C1 ○
20kg Bag of Post Fixing Mix We recommend 60kg (3 x 20kg Bags) per post	648071 ●

● Stock items ○ Made to order (cannot be cancelled once ordered)



Inspirational

Many thanks to our customers who have shared their projects with us, without these inspirational images it would be difficult for us to show you the many ways that our products can be used.

If you have any photos of our products in your garden projects we'd love to see them, please email: pics@jacksons-fencing.co.uk



To see our latest prices, view our Venetian Retreat on our website by scanning the QR code



Woven Retreat

Designed using Jacksons' popular Woven panels for the sides and roof. The Woven Retreat Garden Shelter is a unique garden structure that will create a delightful 'retreat' in any garden.



The Woven Retreat shown here is the standard single unit version. If desired an extra panel can be added at the open side (extra panel not included). The Woven Retreat shelter is available with or without a polycarbonate roof sheeting.



Jacksons came recommended by the contractor carrying out some landscaping/gardening work and we have been more than happy with the purchasing process and the resulting finish of the product now that it's in place.

Brian McShane, March 2019.

The polycarbonate panel sits on top of the Woven roof panels with the rear edges, protruding over the rear fascia to allow rain water to run off and with the polycarbonate box section channels running in line with the pales, across the roof. (Please note if you select the polycarbonate roof option the roof sheet may be delivered separately from the main timber delivery and can only be delivered in the mainland UK).

Specifications: The shelter is constructed from Jakcure® treated softwood, planed all round and guaranteed for 25 years. Fixings are stainless steel or hot dip galvanised. It is 2100mm high at the front and 2000mm high at the back. 1676mm from front post to rear post, (1923mm including roof overhang) 3325mm wide. We advise always digging the posts 600mm in the ground.

Instructions for installation of most of our products are available from our website. Alternatively we can send you a hard copy. Please enquire with our sales team.

Woven Retreat

Description	Ref
Woven Retreat without polycarbonate roof covering	655705BM ○
Woven Retreat with polycarbonate roof covering	655715BM ○
Gutter kit for optional roof sheet (including gutter and downpipe)	673007BM ○
Additional side panel (to fill the right hand side)	655705C1 ○
20kg Bag of Post Fixing Mix. We recommend 60kg (3 x 20kg Bags) per post	648071 ●



To see our latest prices, view our Woven Retreat on our website by scanning the QR code

Wheelie Bin Stores

The Bin Store is made from Jakcure® treated softwood Tongue and Groove Effect boards and has an internal galvanised steel frame for extra strength.



Cabin hooks optional extra

It is designed for two wheelie bins, with hinged doors at the front and hinged lids which open upwards to allow access to the bins. Each lid has a chain which can be attached to the wheelie bin, so as the store lid is lifted it automatically raises the bin lid as well.



To view our latest pricing scan this QR



An additional optional cabin hook is available to attach to the bin store and lid to hold the lid in a secure open position. All timber used throughout is superior quality Jakcure® treated softwood, planed all round and guaranteed for 25 years. Fixings are stainless steel or hot dip galvanised.

Double Bin Store Dimensions

Outside: 1200mm (h) x 950mm (d) x 1500mm (w)

Inside: 1120mm (h) x 800mm (d) x 1350mm (w)

Bin Store with Additional Unit Dimensions:

Outside: 1200mm (h) x 950mm (d) x 750mm (w)

Inside: 1120mm (h) x 800mm (d) x 675mm (w)

Instructions for installation of our products are available. Alternatively we can send you a hard copy. Please enquire with our sales team.

Specifications: Our Bin Store comes as flat packed panels that require self-assembly, instructions and fixings are included.

Wheelie Bin Stores

Description	Ref
Wheelie Bin Store (Double)	660710 ■
Additional Unit Bin Store (Left hanging door)	660711 ○
Single Slatted Shelf (optional)	660712 ○
Cabin Hook (300mm) Galvanised	351666 ■

Please note: Wheelie bins can vary in size - please measure your bin to ensure it will fit in the store. You can only use the shelf in an additional unit, not the main double store.

We reserve the right to alter specifications accordance with our policy of continuous improvement.

■ Check for availability ○ Made to order (cannot be cancelled once ordered)



I'd been looking for a wheelie bin store for a while. I wanted one that looks nice and will last. I wasn't disappointed..excellent quality, clear Instructions and easy to put it together I'd definitely recommend.

Lyn Edwards, June 2020.



Shelf unit will not work in the double store and will only work with the additional unit.

Sissinghurst Planters

These beautifully designed planters will add a touch of class to any corner of your garden.



Available in two sizes, the planters are produced from strong 25mm x 120mm heavy duty planed tongue and groove boards made from Jakcure® treated softwood timber. (100mm visible).



Fantastic product. Best I could find.
Professional, brilliant communication and delivery.
Second time we've used them.
Absolutely superb service!
M.S., February 2019.

The 'L' formation corners are produced from 95mm x 22mm boards and the base consists of 95mm x 22mm slats with small drainage gaps with a planed finish. These sit approximately 80mm off the ground, on 38mm x 19mm battens.

Jacksons Fencing products and planters are renowned for their quality and sturdiness, this does mean that these planters are rather heavy, especially when they are filled, so you may require assistance when moving and we recommend they are moved into position whilst empty. The planters are delivered already assembled.

All timber used throughout is superior quality Jakcure® treated softwood, planed all round and guaranteed for 25 years. Fixings are stainless steel or hot dip galvanised.

Specifications: The internal dimensions of the planters are 440mm x 440mm for the smaller square planters (753200) and 440mm x 900mm for the larger long planter (753201). Both styles of wooden planter have a depth of 380mm internally.

Sissinghurst Planters (external dimensions)

Description	Ref
Square 560mm x 560mm x 500mm	753200 ■
Long 1010mm x 560mm x 500mm	753201 ■

■ Check for availability



Courtyard Gates

Our range of standard Courtyard gates have been crafted with care to be of the highest possible quality.



Hythe Courtyard Gates with J-lock and timber clad posts



We offer three fully clad styles: Hythe (top photo) with its gentle arched top, Sandwich, with a curve to the top of the gate leaves (top right photo) and Rye with its level top (bottom right photo).



Sandwich Courtyard Gates with optional extra black PPC posts

Our Courtyard gates incorporate a galvanised steel internal frame for extra strength and durability. This eliminates the risk of gates dropping or twisting. The gates are clad both sides with timber which matches our Tongue and Groove Effect panels. You can see the best side from both sides - from inside your property as well as the road.

All timber used throughout is superior quality Jakcure® treated softwood guaranteed for 25 years. The gates feature integral hinges that provide maximum tuning flexibility on site. We can manufacture gates to your specification and would be happy to provide quotes accordingly.

Please note: For Courtyard Gates, it is strongly advised to purchase our galvanised steel gate posts as these are designed to provide the strength for a trouble free service life. If you are considering installing onto your own posts or into brick piers, we recommend seeking advice from a qualified engineer as to their suitability, as these gates are very heavy. Consideration should be given to both weight and wind loading. When hanging gates on new brick piers, we recommend galvanised posts with extended hinges which the piers can be built around. Timber clad as an option. Matching Jakcure® treated cladding can be supplied to cover the galvanised gate posts, to give the appearance of wooden posts, or they can be coated black as above.

Our Courtyard gates are manufactured for manual operation as standard. They can be automated, but please call us to discuss your exact requirements before ordering, as the gates have to be designed and modified in production for automated operation. Gate fittings are galvanised as standard

Our gate designs incorporate an internal galvanised steel frame for extra strength and durability. This eliminates twisting and warping which is common in other Courtyard style gate designs. included above in the top right photo.



Rye Courtyard Gate



Our gate designs incorporate an internal galvanised steel frame for extra strength and durability. This eliminates twisting and warping which is common in other Courtyard style gate designs.



To see our latest prices, view our Courtyard gates on our website by scanning the QR code

Courtyard Gates

Style	Height	Width	Ref
Clear Opening Rye Courtyard Gate	1.80m	3.10m	278770BM ○
Clear Opening Rye Courtyard Gate	1.80m	3.60m	278660BM ○
Clear Opening Hythe Courtyard Gate	1.80m	3.10m	278110BM ○
Clear Opening Hythe Courtyard Gate	1.80m	3.60m	278090BM ○

Additional Items

Galvanised post for 1.80m high Rye Courtyard Gate	079093R ○
Galvanised post for 1.80m high Hythe Courtyard Gate	079093 ○
Extra over for timber clad posts	CY-CLAD
J-lock (fitted)	357700BM ■
Stop post	351900BM ■

We have reduced lead time on standard sizes of the Hythe and Rye gates. For any other style or size please ask for a quotation, with no obligation.

■ Check for availability ○ Made to order (cannot be cancelled once ordered)

Railing Panel & Cathedral Gates

In addition to the standard fully clad Courtyard Gates, we have developed these very stylish premium variations with the inclusion of decorative steel insets.



Railing Panel Gates

Cathedral Gates

All timber used throughout is superior quality planed finish Tongue and Groove Effect infills using Jakcure® treated softwood, guaranteed for 25 years, with galvanised fittings for an extra long life.



Railing Panel Courtyard Gates

This distinctive design takes our courtyard gates to a new dimension. The railing panel gates were inspired by our railing topper panels, featured on pages 14 - 15. They also combine our expertise in working with metal and wood to great effect.

As you can see these gates have an attractive panel inset in the top third of the gate each gate leaf, in this case with optional galvanised and polyester powder coated posts. Simple yet effective, collar motifs on alternate bars add an elegant touch.

Cathedral Courtyard Gates

Cathedral Courtyard gates truly showcase timber and metal to great effect. The gentle curve of each leaf give the gates an elegant, stately, concave shaped top when they are closed. They are supplied with galvanised and black powder coated gate posts.

Please ask for a quotation for either of these gates made to order to fit your driveway or entrance.

Our Courtyard gates are manufactured for manual operation as standard. They can be automated, but please call us to discuss your exact requirements before ordering, as the gates have to be designed and modified in production for automated operation.



We found Jacksons to be very efficient throughout the process, from placing the on-line order through to delivery. In addition, we are very happy with the products we purchased.

Stephen, December 2019.

Timber Sliding Gates

Our timber sliding gates are designed in a similar way to our Courtyard Gates for situations where space is at a premium or sliding operation is recommended to add additional privacy and control.



Rear view of gate

All timber used throughout is superior quality planed finish Jakcure® treated softwood, guaranteed for 25 years, with heavily galvanised fittings for an extra long life.



Gates without a Track (cantilever)

The 63mm wide gate frame is clad both sides with a 95mm x 17mm Tongue and Groove style infill. The gates are supported on two square posts and the gates slide on a special steel beam that is fixed to the gate through adjustable rollers that ensure a smooth operation. The automation equipment that can be supplied is detailed on pages 107 - 109 but if you want automated gates they will need to be modified to suit.

The top of the gate is supported on a channel through two pairs of rollers. The gate closes into guides on a catch post. The support posts and the catch post are fitted with base plates for bolting to foundations and are heavily galvanised to give a long life. Posts are supplied galvanised, or galvanised and powder coated black or timber at extra cost.

Gates with a Track (tracked)

The 100mm x 65mm gate frame is clad both sides with a 95mm x 17mm Tongue and Groove style infill. The gate is fitted to a 200mm x 100mm hollow section galvanised steel tube fitted with two heavy duty wheels that run on a track that is set in concrete.

The gate is supported with 3 'portal' (columns) that are bolted to the concrete foundations. Other methods of control are detailed in the automation section of this brochure pages 106-107. Automation offers the most reliable, convenient and safe option for opening / closing sliding gates.

Our timber sliding gates are built to your requirement and specification and we are happy to provide quotes accordingly. Prior to manufacture we will provide fully detailed drawings for your approval.



We have used Jacksons a few times to procure fencing and gates, the quality is excellent, and delivery is very prompt. Their pricing is also very competitive. I would highly recommend them to anyone who needs fencing and gates, they are the best for choice and range of products.

Mrs M, April 2019.



Ornamental Gates

Our ornamental gate designs can be incorporated to all manner of purposes including driveway and entrance gates to secure the front of your property. With many traditional designs to choose from or bespoke options. We ensure that we have the designs available for each individual scenario.



ArchedTopOrnamentalGate



Level Top Gates (standard style)

Ornamental gates are available in two designs, Arched Top Ornamental gate and Level Top Ornamental gate and in three styles: Style A, Style B and Standard.



Level Top Ornamental sliding gate automated (Style B with decorative rings top and bottom).



Style A

Short additional pales with a finial top have been inserted between the pales at the bottom of the gate.

Style B

Decorative rings are inserted between the pales at the top and the bottom.

Standard

Decorative rings are inserted between pales at the bottom.

Built to Stay Looking Good

Constructed in corrosion resistant hot dip galvanised steel and generally supplied with an additional polyester powder coating, in a choice of standard colours, green, black, white, blue or grey (other colours on request).

- Two classic designs to choose from with three style variations
- Corrosion free hot dip galvanised finish
- Additional colour coatings

If you let us know the width of your gateway, height of gate, design type and whether it's for manual or automatic operation, we will supply you with a quotation without obligation.

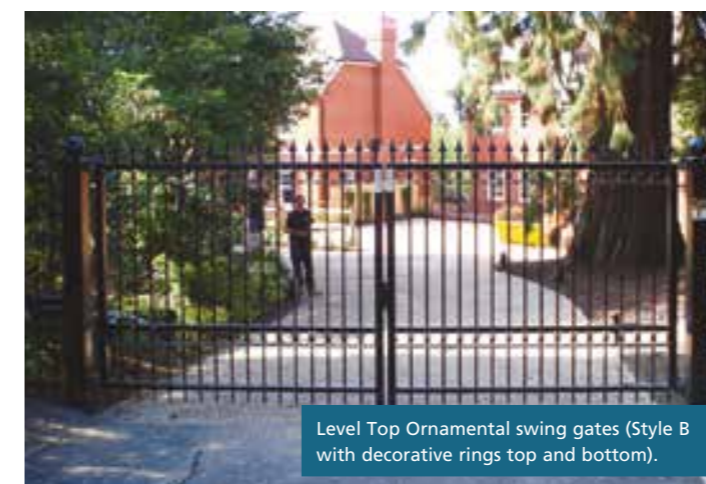

Level Top Ornamental swing gates (Style B with decorative rings top and bottom).

“
I couldn't be happier with the products and service received from Jacksons Fencing. I was looking for decking that would look outstanding and also stand the test of time. Jacksons gave me all of that and more. It gives me peace of mind knowing I have a 25 year guarantee.
Mrs Smith, Kensington.



Arched Top Ornamental swing gates with ornamental fencing (style A).



Auto-Gate Operators

Our automated gates provide increased security, convenience and look prestigious.



The many advantages of automated gates are now widely recognised by residential users. They bring security against intruders, all-weather ease of operation and prestige.



A truly a great experience. I'm a professional builder, project manager of Royal Estates Design & Build. Throughout this Covid pandemic it's been an absolute nightmare, however Jacksons were totally organised. I usually am very critical of most suppliers but this firm was faultless. My order was on time and the quality "the very best" great materials and well put together, couldn't be happier. Thank you genuinely 100%.

Mr R. Ashong, Royal Director.

However, while choosing the right gate for a situation is hard enough, the prospect of successfully navigating your way through the pros and cons of which automatic gate operator to choose can seem daunting to contemplate. We realise this, which is why we see it as our responsibility to guide you smoothly through the process. At Jacksons our gate automation specialists will talk you through the best operator to suit your gate and which devices you need, e.g. a push button, remote control handsets, or audio entry systems.

At Jacksons we ensure your investment in automation works and that it is CE marked and complies with the EU Machinery Directive, which means the gate will not be a danger to you, your family or visitors.

Rear Mounted Swing Gate Operators:

Ideally suited to gates up to a maximum of 7m wide per leaf with a maximum opening of 90°.

Underground Operators: (electro-mechanical)

For installation below ground under each gate post, Underground Operators are ideally suited to solid timber gates, or courtyard gates up to a maximum of 4m each leaf. Designed for heavy residential and light commercial use, when maintenance is required the operators can simply be removed from the foundation box without removing the gate. Underground Operators can go up to 180° opening

We have detailed the various gate operators, access control options and additional safety devices available in the following two pages which will help your dream of having an automatic gate become a reality.





Hard-wired Audio Intercom

Voice link between gate and a handset in a building featuring a release button for the gate (available with or without keypad, flush or surface mounted).



GSM/Landline Audio Intercom

Voice link between gate and building without cabling. Option of signalling via ex-directory landline or valid mobile phone SIM card. (1 - 1,000 users, with or without keypad, flush or surface mounted, various out-station finishes).



Key Pad & Intercom

Usually surface mounted with optional illuminated numbers. A PIN number type access control from a single user code to multiple user codes.



Hard-wired Video Intercom

Voice and moving picture link between gate and a handset in a building featuring a release button for the gate (available with or without keypad, flush or surface mounted with handset and hands-free options).



Remote Key Fob

Operates a device from a remote distance, range subject to proximity of buildings and atmospheric conditions.



Residential Auto-Gates Access Control Options

Our access control systems provide the means to control the operation of our automated products, for example, to send a signal to open or close an automated gate or raise or lower a traffic barrier. These options are shown on these pages.

In addition we can also offer a range of additional safety devices that will allow you to augment standard features or to tailor your automation and access control system to suit your application.

Ground Loops

These are cut into tarmac or concrete road surfaces to create an electro-magnetic field that will signal an action when a vehicle enters or exits from it. Can be preframed.

Safety Edges

Rubber strips with built in electronic sensors that will signal an action when in contact with a solid object.

Traffic Lights

A universal method of informing a driver when it is safe to proceed through a gate opening or over a road blocker.

Photo Cells

The 'magic eyes' will see an object or person and stop the gate hitting it.

Safety And The Law

When specifying new automated gates and barriers or the retro-fitting of automation to manual products, it should be noted that both the gate and its automation should be viewed holistically and that in combination, as a machine, they must comply with the legislation. All machines placed on the market in the European Union have a legal requirement to comply with the EU Machinery Directive is 2006-42-EC. In the UK this European law is implemented by The Supply of Machinery (Safety) Regulations 2008. This regulation requires all machines to meet a set of 'essential health and safety requirements' and to be CE marked as proof of compliance.

Jacksons Fencing operates a continuous product development programme to ensure the latest improvements to safety are incorporated into our products at the earliest opportunity and fully comply with prevailing legislation. Failure to exercise a duty of care in the specification, design, installation or operation of compliant automated gates may mean the specifier, client and site operator face litigation in the event of an accident involving injury or damage to property. Jacksons automated gates and barriers meet with the essential health and safety requirements and are properly CE marked as required by law.

Additionally the products are designed and engineered to exceed the standards set out in BS EN 12978 and BS EN 12453 in relation to gate safety. Jacksons Fencing is an Automated Gate Safe Aware and D.H.F Installer.

Quality Guaranteed

Your Auto-gate will be fitted by fully qualified Jacksons staff to ensure satisfactory working and a Gate Safe compliant installation. Rest assured, like all Jacksons products, Auto-gates are simply the best quality and with advanced components available. We are so confident we offer a 25 month guarantee on all parts and that even includes installation too, subject to a maintenance agreement being taken out. In addition you will have the equipment serviced at no charge.

Safety Notes

Please read: If you are considering automating any existing gates, please ask for advice. For any Jacksons entrance or uni-gates to be fitted for automation, we insist that an extra heavy bottom rail across the width of the gate is fitted to cope with the forces and reduce the chance of twisting. It is also essential for any swing gates that are automated to be fitted with finger guards.

Please note: we reserve the right to alter specification in line with our policy of continuous improvement.



Entrance Gates for the Drive or Field

Our entrance gates are designed with a heavy rail across the top for extra strength.



All timber used throughout is superior quality planed Jakcure® treated softwood guaranteed for 25 years. Rail and brace crossings are fixed with stainless steel bolts. The gates are cross braced for extra strength and all joints are morticed and tenoned.

To see our latest prices, view our Entrance gates on our website by scanning the QR code



Gates are 1.20m high except for the hanging stile which is 1.50m. Hanging Stile 125mm x 75mm, Slam Stile 75 x 75mm, Top Rail is 100 x 75mm and under rail and cross braces 75mm x 25mm (all nominal). Supplied in natural Jakcure® finish. As standard, larger sizes are right hand hanging, smaller sizes are left hand hanging, see below for details.

Entrance Gates - Narrow Specification (0.90m - 1.50m wide)

Single cross braced. Gates are 1.20m high except for the curved hanging stile which is 1.50m and slam stile 75mm x 75mm. Top rail is 100mm x 75mm. Left hand hanging when viewed from the front (opposite hanging available at no additional cost).

Length	LHH Ref	RHH Ref
0.90m	262800 ■	262880 ■
1.20m	262900 ■	262990 ■
1.50m	263000 ○	263090 ○

Fitting Pack

Description
Items required for hanging a single narrow entrance gate; Galvanised fittings, Hinge set, Spring catch, Anti-lift device, Padlock & two 2.10m, 150mm x 150mm gate posts.

Ref
TRHSSLN ●

Safety Notes - If you are considering automating these gates please ask for advice and quotation. For any Jacksons five bar gates to be retro-fitted for automation we insist that an extra heavy bottom rail across the width of the gate is fitted to avoid twisting. It is also essential for any swing gates that are automated to be fitted with finger guards. See residential Auto-Gates pages (107-109) for more info. All catches and latches are for adult operation only - children must be supervised.

Entrance Gates - Wide Specification (1.80m - 3.60m wide)

Items required for hanging a single wide entrance gate; Galvanised fittings, Hinge set, Spring catch, Anti-lift device, Padlock, 2.10m x 175mm x 175mm Hanging post and 2.10m x 150mm x 150mm Shutting post. Right hand hanging when viewed from the front (opposite hanging available at no additional cost).

Length	LHH Ref	RHH Ref
1.80m	263110 ○	263100 ○
2.10m	263220 ○	263200 ○
2.40m	263330 ○	263300 ○
2.70m	263440 ○	263400 ○
3.00m	263550 ■	263500 ■
3.30m	263660 ○	263600 ○
3.60m	263770 ■	263700 ■

Fitting Pack

Description
Items required for hanging a single gate; Galvanised fittings, Hinge set, Spring catch fitted, Anti-lift device, Padlock, 2.10m, 175 x 175mm hanging post and 2.10m, 150mm x 150mm Shutting post.

Ref
TRHSSL ●

Items required for hanging a double wide entrance gate (includes loop over, drop bolt & centre gate stop etc.)

Ref
TRHSDL ●

Additional Fitting packs / Hanging systems can be found on page 113.

● Stock items ■ Check for availability
○ Made to order (cannot be cancelled once ordered)

Uni-Gates for the Drive or Field

Our Uni-Gates are called this as they are 'Universal' which means they can be hung as right or left handed. They are designed with a heavy top rail over the entire width for extra strength.



All timber used throughout is superior quality planed Jakcure® treated softwood guaranteed for 25 years. Top bars are chamfered and both hanging and slam stiles are drilled to allow gates to be hung on the left or right. Rail and brace crossings are bolted with stainless steel bolts. The gates are cross braced for extra strength and all joints are morticed and tenoned.



Gates are 1.27m high overall. Top rail 100mm x 75mm, under rail and cross braces 75mm x 25mm. Hanging and slam stiles (rounded top) 100mm x 75mm (nominal sizes), with both stiles drilled to allow gates to be hung on the left or the right. Supplied in natural Jakcure® treated finish.

Uni-Gates - Narrow

Specification (0.90m - 2.10m wide)

Length	Ref
0.90m*	255000 ●
1.05m*	255090 ●
1.20m	251100 ●
1.50m	255200 ●
1.80m	255300 ●
2.10m	255400 ●

*with a single brace

All gates can be hung either left or right.

Should you want to create a symmetrical pair of narrow gates with braces mirroring each other. The customer will need to advise us to make a right hand to match the left hand standard gate

We also recommend our gates are hung behind the posts as this helps to hold the gate when closed.

Fitting Pack

Description	Ref
Items required for hanging a single gate; Galvanised fittings:- Hinge set, Spring catch fitted, Anti-lift device, Padlock, 2.10m, 175 x 175mm hanging post and 2.10m, 150mm x 150mm Shutting post.	TRHSSL ●

Additional Fitting Packs / Hanging systems for Uni and Entrance Gates

Description	Ref
For double leaf gates hung behind posts, inc Hinges, Loopover, CGS, Fitting of irons - NO POSTS	TRHSDLNP ●
For single leaf gate hung behind posts, inc Posts, Hinges, Auto catch, Fitting of irons	TRHSSLAC ●
For single leaf gate hung between posts, inc Posts, Hinges Spring catch, Fitting of irons	TRHSSLBP ●
For narrow leaf Uni or Entrance gate hung behind posts, inc Posts, Hinges, Auto catch, Fitting of irons	TRHSSLNAC ●
For narrow leaf gate hung between posts, inc Hinges, Spring catch, Fitting of irons	TRHSSLNBP ●
For single leaf gate hung behind posts, inc Hinges, Spring catch, Fitting of irons - NO POSTS	TRHSSLNP ●
For single leaf gate hung behind posts, inc Hinges, Auto catch, Fitting of irons - NO POSTS	TRHSSLNPAC ●
For single leaf gate hung between posts, inc Hinges, Spring catch, Fitting of irons - NO POSTS	TRHSSLNPBP ●



Inspirational

Many thanks to our customers who have shared their projects with us, without these inspirational images it would be difficult for us to show you the many ways that our products can be used.

If you have any photos of our products in your garden projects we'd love to see them, please email: pics@jacksons-fencing.co.uk

Uni-Gates - Wide

Specification (2.40m - 4.20m wide)

Gates are 1.27m high to the top of the stile. Top rail 100mm x 75mm (nominal sizes), under rail and cross braces 75mm x 25mm. Hanging and slam stiles (rounded top) 100mm x 75mm, with both stiles drilled to allow gates to be hung on the left or the right. Supplied in natural Jakcure® treated finish.

Length	Ref
2.40m	255500 ●
2.70m	256600 ●
3.00m	257700 ●
3.30m	258800 ●
3.60m	259900 ●
3.90m	256000 ●
4.20m	256100 ●



To see our latest prices, view our Uni gates on our website by scanning the QR code

● Stock items ■ Check for availability
○ Made to order (cannot be cancelled once ordered)

Safety Notes - Please Read: If you are considering automating these gates please ask for advice and quotation. For any Jacksons five bar gates to be retro-fitted for automation we insist that an extra heavy bottom rail across the width of the gate is fitted to avoid twisting. It is also essential for any swing gates that are automated to be fitted with finger guards. See residential Auto-Gates pages for more info. All catches and latches are for adult operation only - children must be supervised.

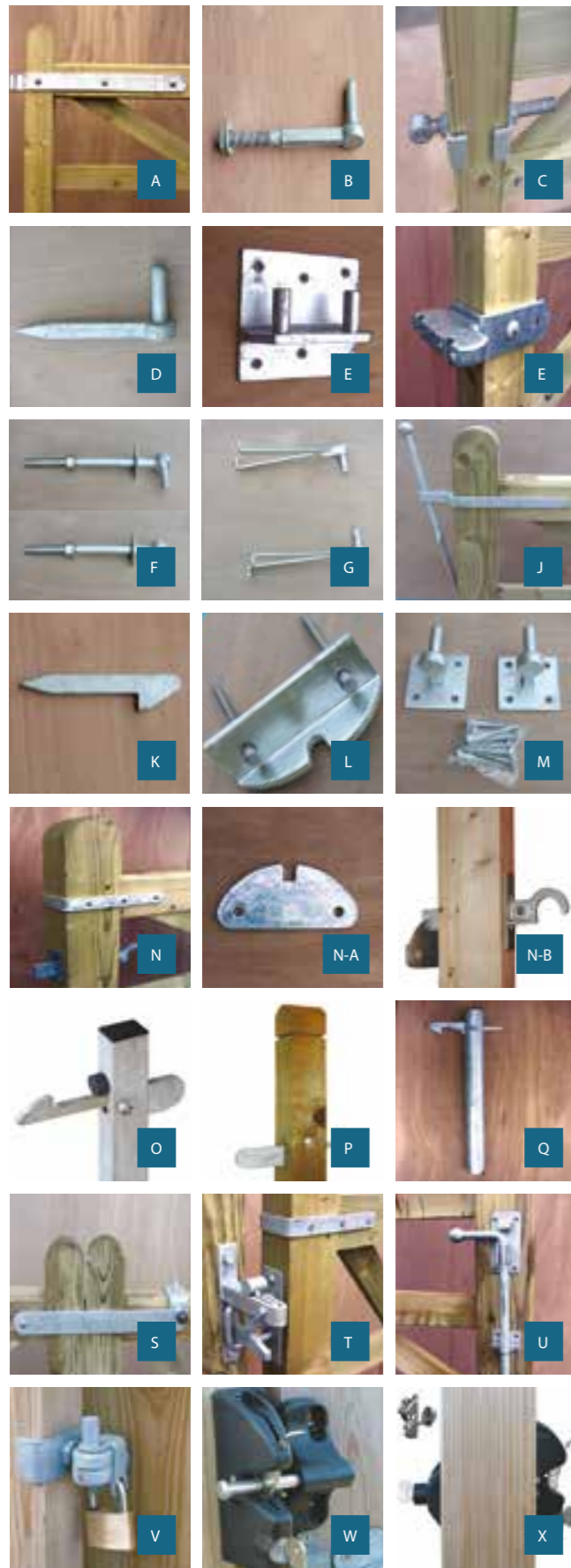

Gate Fittings and Accessories

Description	Ref
Spring Catch Set made up of (H,J,K) For use behind posts	271300 ●
Spring Catch Set as alternative to item K (H,J,L) For use between posts. Posts must be taller than gate	271350BM ●
Hinge Set with adjustable bottom hinge for wooden posts supplied with anti-theft nuts (A,B,C,D)	271800 ●
Hinge Set with hooks to build into brickwork (A,C,G)	274100 ●
Hinge Set with double swing rockerbottom hinge for wooden posts (A,B,E)	350100 ●
Pair Hooks on 100mm plate 19mm pin (M) (for use with timber wall plates)	438400 ●
Pair of Hinge Hooks for concrete or wooden posts from 150mm - 250mm (extra long) (F)	438500 ●
Wrought Heavy Latch for gates with rocker bottom hinge shown pic N. Constituent parts shown in pics marked N-A and N-B	351010BM ●
Gate Catch to fix in cement with wear plates (O)	1BSLPOST-BM ●
Gate Catch with wooden stump and wear plates 1.80m x 100 x 100mm to support full height of gate and catch on 2nd rail down for use on Entrance and Uni- Field gates (P)	351800BM ●
Universal Hold Back Catch for wood or metal gates with wear plates (Q)	272000 ●
Loopover Catch complete with bolt (for connecting two gates) and staple with extra knob (S)	271410 ●
Auto Catch with striker (T)	438300 ●
Drop Bolt (U)	351400 ●
Heavy Lockable Drop Bolt - Similar to option 'U'	351410BM ●
Anti-Lift device (V) for padlock (Not for use with hooks on plates Ref 4384)	271200BM ●
Fitting irons to gates (our fitting charge)	271700 ●
Gate Latch-GRP General Purpose - 1 way lockable (W)	354600 ●
Gate Latch Deluxe 2 Way lockable - rust free, lock from either side of the gate (X)	354700 ●

Safety Warning: Jacksons' magnetic pull latches are designed to be operated by adults only. Children must be supervised at all times if operating moving parts.





To see our latest prices, view our Gate Fitting & Accessories on our website by scanning the QR code

Self Closing Adjustable Hinge

Gives vertical and horizontal adjustment with the stainless steel spring ensuring that the gates always close. We recommend that it is used with the magnetic latch range, for gates up to 1.50m.

Description	Ref
Self closing adjustable hinge for timber gate (A)	354400 ●
Self closing adjustable hinge for steel gate (B)	354420 ●

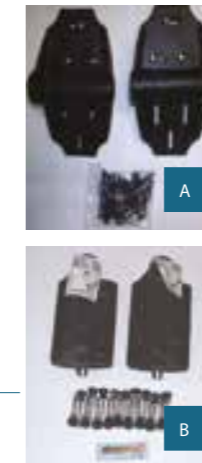

The Vertical Pull Latch

Ideal for gates that need to always to be closed, for example swimming pool gates and where you need to confine pets.

Description	Ref
Vertical Pull Latch (C)	354330 ●



The Extended Pull Latch

The same as the Vertical Pull Latch but the handle has been extended to ensure toddlers cannot reach the latch.

Description	Ref
Extended Pull Latch (D)	354500 ●



The Pull Latch

A general all purpose latch suitable for gates that do not require the security of a keyed lock.

Description	Ref
Pull Latch (E)	354200 ●



● Stock items ■ Check for availability
○ Made to order (cannot be cancelled once ordered)

Gate Posts

Square with tops shaped four ways. The gate 2.40m 150mm x 150mm and 2.70m 175mm x 175mm. Hanging posts are stress relieved by having a saw cut in the middle of one side allowing the timber to move as it dries out or swells according to the weather, thus avoiding unsightly splits. The hanging posts should be placed so the stress relieving cut is at 90° to the gate hinges. For ballast & cement see page 146. We recommend that for gates 2.40m and wider 175mm x 175mm posts are used.

Hanging Posts for field gates (Stress Relieved - SR)	Section	Ref
(SR) 2.10m Fine sawn finish	175mm x 175mm	272400 ●
2.10m Fine sawn finish	150mm x 150mm	274000 ●

Gate Posts for special gates (Stress Relieved - SR)

2.40m Fine sawn finish	125mm x 125mm	272500 ●
(SR) 2.40m Fine sawn finish	150mm x 150mm	273900 ●
(SR) 2.40m Fine sawn finish	175mm x 175mm	273800 ●
2.70m Fine sawn finish	125mm x 125mm	272600 ●
(SR) 2.70m Fine sawn finish	150mm x 150mm	274090 ●
(SR) 2.70m Fine sawn finish	175mm x 175mm	273880 ●

Wall Plates

Planned finish dimensions before treatment.

Description	Section	Ref
1.80m Planned finish	95mm x 70mm	228000 ●
2.10m Planned finish	95mm x 70mm	228050 ■
2.40m Planned finish	95mm x 70mm	228100 ■
1.80m Planned finish	95mm x 45mm	171000 ●
2.10m Planned finish	95mm x 45mm	171021 ●
2.40m Planned finish	95mm x 45mm	171024 ●

Centre Gate Stops

Description	Ref
For use with Entrance and Uni-Gates	927110 ■
Courtyard Gates 65mm	927120 ●
Featherboard and boarded gates	602200 ■

Heavy Metal Field Gates

A heavy duty gate is essential for any farm, field or agricultural settings. Our high quality heavy metal field entrance gates are available in a range of designs and sizes. We offer a selection of two styles of metal field gates available singularly or in pairs with a choice of drop bolts. They arrive in a galvanised finish.

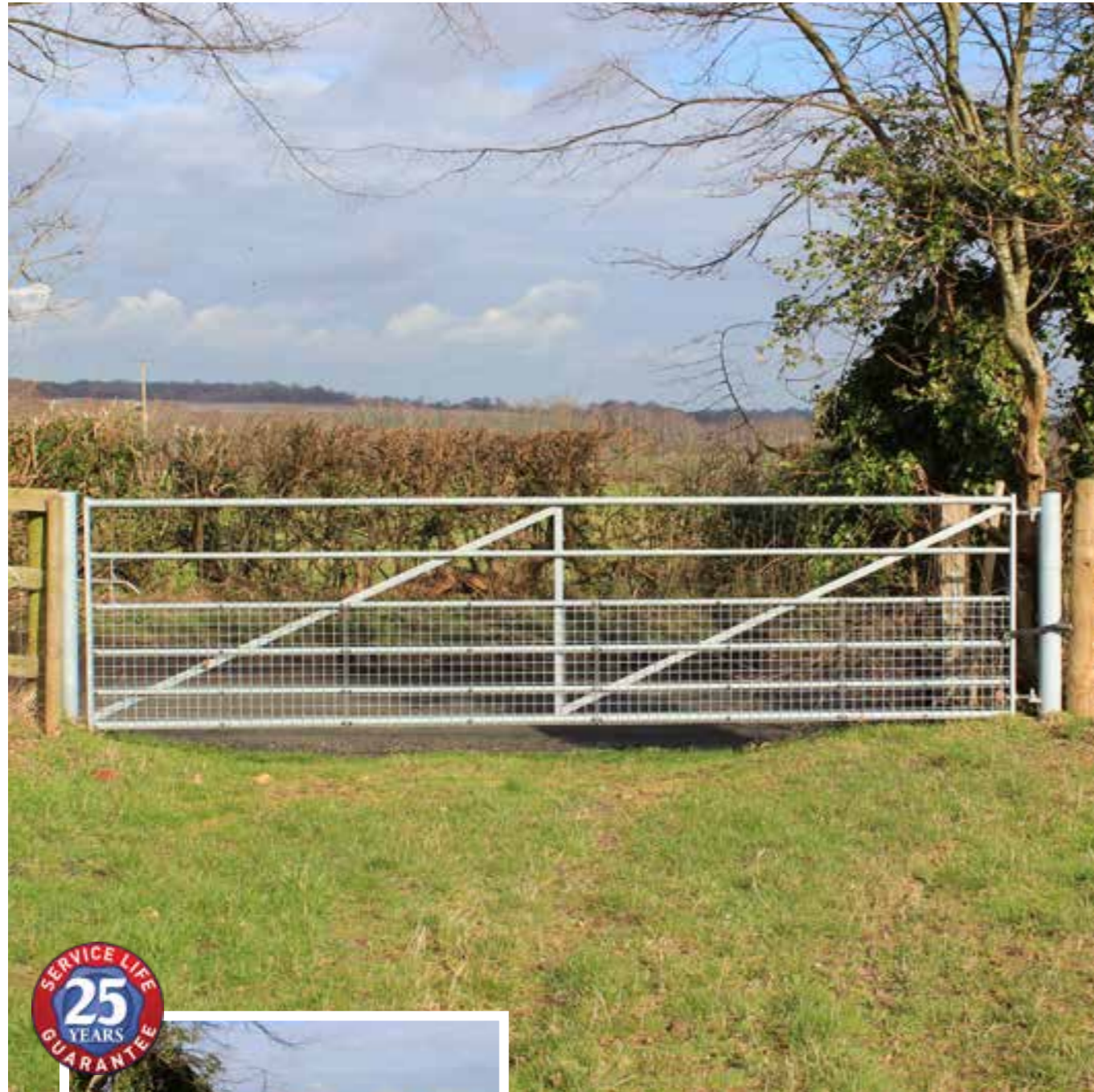

The top and bottom rails are 41.5mm tube, with middle rails which are 32mm tube.



Specification: Gates are 1.15m high. Hanging stile of 50mm x 25mm box section. Slam stile of 50mm x 25mm box section. Top and bottom rails 41.5mm tube, with middle rails 32mm tube. Fittings include adjustable hinges and padlockable sliding latch. Also available with welded mesh cladding, (600mm high x 50mm x 50mm x 4mm) to the bottom part of the gate, please see below.

Heavy Metal Field Gates

Length	Standard Un-clad Ref	Price	Clad with Wire Mesh Ref
1.20m	440800 ○	£116.45	440880BM ●
2.10m	441100 ○	£143.30	441110BM ●
2.40m	441200 ○	£153.00	441220BM ●
2.70m	441300 ○	£163.25	441330BM ●
3.00m	440200 ●	£167.25	440220BM ●
3.30m	440300 ●	£176.45	440330BM ●
3.60m	440400 ●	£185.75	440440BM ●
4.20m	440500 ●	£204.60	440550BM ●
4.60m	440600 ●	£226.80	440660BM ●

Welded mesh should normally be clad to inside of the gate with bracing on outside to avoid animals climbing up the rails. Please also note: Any metal field gate clad with mesh should be hung on 114mm diameter posts.

Drop Bolts and Loop Over Catches

Description	Ref
Drop bolt	453880 ●
Loop over catch	453700 ●

Drop bolts and loop over catches are available for self fitting if pairs are required.



Gates and fittings look good quality, delivery was as planned, cost was competitive. In short, I am very pleased and happy to recommend using this company
Mike, October 2019.

Hanging Posts

Description	Ref
1.875m long x 89mm Diameter	453200 ●
1.875m long x 114mm Diameter	453100 ●

89mm diameter posts should be used up to 3.30m wide 114mm diameter posts should be used on 3.30m wide and above.

Slam Posts

Description	Ref
1.80m long 88.9mm Diameter	453600 ●

● Stock items ○ Made to order (cannot be cancelled once ordered)



Due to the erratic price changes in raw material, we have temporarily removed prices from our Good Fencing Guide.

To see our latest prices, view our Heavy Metal Field Gates on our website by scanning the QR code.

Estate Railings & Gates

Estate fencing has a classic style that everyone associates with country parks and rural estates.

Our traditional estate fencing is ideal for use as a continuous boundary fence in parkland, paddocks, deer parks, estates or estate grounds. The fencing is constructed from steel and is galvanised as standard. Our fencing and gates can be powder coated to your choice of colour.



Our Estate Fencing is ideal for use on uneven ground as it follows the contours of the ground and can easily be stepped. Please note: panels can only be stepped, not raked. Images show optional black PPC finish.



We have improved the traditional fence design and created an economical, modern, tubular version that is stronger, lighter and virtually maintenance free. All of our steel fencing is galvanised and has a 25 year service life guarantee.

Metal Estate Railing Fencing

Description	Ref
Panel 2.00m wide overall x 1.20m high above finished ground level. End posts/uprights 50mm x 25mm RHS (end posts are drilled with 2 holes for bolting to the next panel). Product is galvanised as standard and PPC black is an optional extra.	079800 ○
End post for cut back panel	079801 ○
M8 x 65 Coach Bolt (2 per panel)	804100 ○
M8 washers	073304 ○

Estate Railing Gates

Manufactured from the same high quality materials and with all the same benefits as the Estate Railings, this elegant gate is ideal for use with railings or in the place of any metal field gate. The graceful crook with the diagonal strengthening brace adds an attractive feature.

Any metal field gate clad with mesh should be hung on 114mm diameter posts.

Estate Railing Gates

Description	Ref
1.20m wide	079400BM ○
3.00m wide	079500BM ○
3.60m wide	079600BM ○

Galvanised as standard, powder coating available as an option - please ask. Posts are filled with heavy duty black plastic infills, for all colours including galvanised.

○ Made to order (cannot be cancelled once ordered)



Really pleased with the quality of the product. Delivery driver was very helpful and dropped the items where convenient for me. Helpful installation guide on the website. Looks great.

Mr Body, December 2019.



Due to the erratic price changes in raw material, we have temporarily removed prices from our Good Fencing Guide.

To see our latest prices, view Estate Railings and Gates on our website by scanning the QR code.

Post & Rail Special Heavy Morticed

This attractive design will appeal to those who want a timeless, traditional or agricultural style fencing with a rustic feel.



Comprising of half round vertical posts, with either three or four mortices, for the irregular sawn horizontal rails to insert into.



Allow one post for every 1.85m of fence, plus one for the end of the run.

For a 3-rail fence allow three rails per 1.85m and for a 4-rail fence, also allow four rails per 1.85m. All timber used throughout is superior quality Jakcure® treated softwood guaranteed for 25 years. The posts have a galvanised gangnail embedded in top to reduce splitting.

Posts

Peeled half round softwood Jakcure® treated with a minimum of 125mm across the face. (Mortices 100 x 40mm are centred at 125mm, 500mm, 850mm, 1150mm from the top of the post).

Length	Ref
1.80m (3 Mortices)	150400 ■
2.30m (4 Mortices)	150600 ○

Rails

Irregular sawn sections of softwood Jakcure® with a minimum girth of 250mm peeled, with ends tapered to fit mortices.

Length	Ref
2.00m approximately	150520 ■



Handy Tip

After dividing the length of the fence run by the post intervals, always add one extra post to complete the run. Remember, corner posts take the place of ordinary posts. Aids for erecting posts - Shuv-holer and Monkey Hole Borer - see page 156.

Corner Posts

Peeled round, softwood Jakcure® treated with a minimum diameter of 125mm. Morticed two ways. (Mortices 100mm x 40mm are centred at 125mm, 500mm, 850mm, 1150mm from the top of the post).

Length	Ref
1.80m (3 Mortices)	150900 ■
2.30m (4 Mortices)	151000 ○

Nails

Description	Ref
1kg bag of 50mm Stainless Steel Nails	800710 ●
5kg box of 50mm Stainless Steel Nails	800750 ●

2kgs required for 180m of 3-rail fence. 3kgs required for 180m of 4-rail fence (441 nails approx. per kg).

- Stock items ○ Made to order (cannot be cancelled once ordered)
- Check for availability



Due to the erratic price changes in raw material, we have temporarily removed prices from our Good Fencing Guide.

To see our latest prices, view our Post & Rail Special Heavy Morticed page on our website by scanning the QR code.

Post & Rail Nailed

This highly durable and versatile fencing comprises of machine rounded half round vertical posts, with three horizontal machine rounded half round rails nailed to the flat face of the posts.



Due to the erratic price changes in raw material, we have temporarily removed prices from our Good Fencing Guide.

To see our latest prices, view our Post & Rail Nailed on our website by scanning the QR code.

Post and Rail Nailed fencing is a robust agricultural style system which can have 2, 3, or 4 rails depending on what is required.



Bought to replace post and rail fencing and pair of gates which had lasted for over 25 years - all items look to be of a similar quality. Special mention for the delivery driver who was a marvellous ambassador for the company.

Ian Brown, April 2020.

Square Post & Rail Fencing

Allow one post for every 1.80m of fence, plus one for the end of the run. This traditional versatile fencing consists of machine rounded half round posts, with three horizontal machine rounded half round rails, nailed to the flat face of the square posts.

Allow three rails for every 3.60m of 3-rail fencing.

All timber used throughout is superior quality Jakcure® treated softwood guaranteed for 25 years.

Recommendation: When erecting post and rail fencing in the Summer it is advisable to set posts in concrete as it is very difficult or impossible to ram dry soil tight.

Machine Rounded, Half Round Posts

Description	Ref
1.80m 115mm face	130400 ●
1.80m 125mm face	150110 ●
2.40m 125mm face	131300 ●

(2.40m posts are recommended for use in soft ground or a 1.50m high fence).

Machine Rounded, Corner Posts

Jakcure® treated softwood with two sawn flat sides from round post of 125mm diameter.

Length	Ref
1.80m	130550 ●

Half Round Rails

Machine rounded half round Jakcure® treated rails.

Description	Ref
3.60m long with 100mm face	135000 ●



Sawn Square Post & Rail Fencing

This sturdy fencing consists of sawn square section posts, with three horizontal rails, nailed to the posts. There is a choice of either half round rails or sawn square section rails.

Allow one post for every 1.80m of fence, plus one for the end of the run. Allow three rails for every 3.60m of 3-rail fencing.

Sawn Square Posts

Length	Ref
1.80m	170100 ●
2.10m	170500 ●
2.40m	170600 ■

125mm x 75mm section, weathered one way. Sawn finish. For corners use ordinary posts.

Square Rails

100mm x 38mm section. Sawn finish.

Length	Ref
3.60m long	170200 ●
4.00m long	170210 ■

For Arenas

Description	Ref
3.60m x 150mm x 38mm Containing Boards	170400 ●
4.00m x 150mm x 38mm Containing Boards	170410 ●
3.60m x 150mm x 25mm Splash Boards	170800 ●
3.60m long x 100mm diameter Jumping Poles (not for in-ground use)	131800 ●
3.60m x 100 x 38mm Square Rails Sawn finish	170200 ●
4m x 100 x 38mm Square Rails Sawn finish	170210 ■

Nails

Description	Ref
1kg Tub of 100mm Galvanised Wire Nails	800310 ●
5kg Tub of 100mm Galvanised Wire Nails	800350 ●

● Stock items ■ Check for availability

○ Made to order (cannot be cancelled once ordered)

Post & Rail Morticed

This attractive fencing consists of sawn square section posts, with three or four horizontal square section rails, morticed into the posts complete with our 25 year guarantee.



There are additional prick posts in between the posts at the mid bay point to give extra support.



Allow one post and one prick post for every 2.85m of fence, plus one post for the end of the run. Allow three rails per 2.85m run of 3-rail fence, and four rails per 2.85m of 4-rail fence.

All timber used throughout is superior quality Jakcure® treated softwood guaranteed for 25 years. The morticed posts have a galvanised gangnail embedded in the top to reduce splitting of the timber.

All fixings are heavily galvanised.

Posts

125mm x 75mm section, weathered one way. Mortices 100mm x 40mm centred at 150mm, 530mm, 885mm and 1190mm from top of post. Sawn finish.

Length	Ref
1.80m (3 Mortices)	190200 ●
2.10m (4 Mortices)	190700 ○

Square Rails

100mm x 38mm section, scarfed at both ends.

Length	Ref
3.00m	190300 ●



Due to the erratic price changes in raw material, we have temporarily removed prices from our Good Fencing Guide.

To see our latest prices, view our Post & Rail Morticed on our website by scanning the QR code.



Fencing and double gate are fantastic quality, really solid. We've had loads of positive feedback from people walking past and the guys who installed it said it made the job so much easier working with quality materials.

Ian, August 2019.

Corner Posts

125mm x 125mm section, weathered two ways. Sawn finish.

Length	Ref
1.80m (3 Mortices)	190600 ●
2.10m (4 Mortices)	190800 ○

Prick Posts

100mm x 38mm section, pointed with a sawn finish.

Length	Ref
1.50m long	190400 ●
1.80m long	190900 ○

Nails

Description	Ref
1kg Tub of 100mm Galvanised Wire Nails	800310 ●
5kg Tub of 100mm Galvanised Wire Nails	800350 ●
25kg Carton of 100mm Galvanised Wire Nails	800300 ●

Allow 11kg for 200m of 3-rail fence and 14kg for 200m of 4-rail fence. Approximately 77 nails per kg.

● Stock items ○ Made to order (cannot be cancelled once ordered)

Chain Mesh Fence

For absolute economy and horse security this fence is highly recommended. It comprises half round vertical posts, machine rounded and pointed. One half round horizontal rail at the top of the fence and galvanised chain link below.



- All timber used throughout is superior quality Jakcure® treated softwood guaranteed for 25 years.
- Specially designed with horse safety in mind.
- Galvanised mesh for longer life.
- Smaller holes in mesh to stop horses' feet becoming caught in wire and causing injuries.
- Superb value.

Allow one post for every 1.8m of fence plus one for the end of the run. Allow one top rail per 3.60m of fence and one 25m roll of 0.90m chain link per 25m run.

Posts

Half round softwood, machine rounded and pointed 125mm across the face.

Length	Ref
1.80m	150110 ●

Half Round Rails

Half round, machine rounded 100mm across face.

Length	Ref
3.60m	135000 ●

Chain Link

50mm mesh conforms to B.S. 1722 Part 1, galvanising conforms to BS EN 10224, wire used is to BS EN 10233. Line wire is supplied with each roll.

Description	Ref
25m roll, height 0.90m, 2.5mm gauge	300100 ●

Corner Posts

Two sawn flat sides from round posts of 125mm diameter.

Length	Ref
1.80m	130550 ●

Staples / Nails

We suggest you use galvanised (barbed) staples 30mm x 3.15mm which would require 3kg. per 200m & 100mm galvanised wire nails 4kg. galvanised ring clips - sufficient for 200m. See page 154.

- Stock items

Fencing Stakes & Posts

This is a versatile and hard wearing general purpose fence suitable for a multitude of agricultural situations. With our Jakcure® treated stakes and galvanised wire it's long lasting too. All timber used throughout is superior quality Jakcure® treated softwood guaranteed for 25 years.

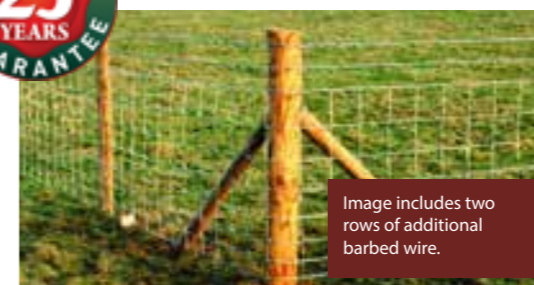

Stakes

Softwood mixed cleft & round 75mm -100mm across or through the butts, peeled, pointed.

Length	Ref
1.65m	090400 ■
1.80m	090500 ■
1.65m (all round 50mm - 75mm)	110660 ■
1.80m (all round 50mm - 75mm)	110770 ■

Machine Rounded Fencing Stakes

Pointed, with chamfered tops.

Length	Ref
1.50m long, 75mm diameter	091800 ●
1.65m long, 75mm diameter	091900 ●
1.80m long, 75mm diameter	092000 ●
1.65m long, 90mm diameter	093200 ■
1.80m long, 90mm diameter	093300 ■

Anchor Stakes

Half round with a minimum of 75mm face, peeled to act as a thrust plate for the struts.

Length	Ref
750mm - 900mm	090900 ■

Straining and Corner Posts

Round and peeled. Diameter measurement is approximate through the butt.

Length	Ref
2.30m long x diameter 150mm	090600 ■
2.70m long x diameter 150mm	091500 ■

Machine Rounded, with Chamfered Tops

Length	Ref
2.10m long x diameter 150mm pointed	093050 ■
2.40m long x diameter 150mm pointed	093055 ■

Straining Posts and struts should be installed at a maximum of every 50m and at all changes of direction and significant changes of level. Intermediate posts for mild steel fencing at 3.50m centres for sheep or 2.70m for cattle.

Peeled and Pointed

Length	Ref
2.30m long x diameter 125mm	090660 ■

Struts

Machine rounded and a minimum diameter of 60mm Jakcure® treated timber.

Length	Ref
1.80m	114900 ■
2.10m	115000 ■
2.40m	115100 ■

For Stock (or cattle) Fence

We also supply wire fencing, wire netting, and barbed wire. Staples and galvanised straining eye bolts and tools page 128, 129 and 152 - 156.

- Stock items ■ Check for availability

Wire Fencing & Netting

Ideal for many applications, including protecting small animals, cages, protecting machinery or in some instances may be used as agricultural fencing.



To view our latest prices, visit Wire Fencing and Netting on our website by scanning the QR code.

Hexagonal Wire Netting

Mesh (50m rolls)	Wire Gauge	600mm (H) Ref	900mm (H) Ref	1050mm (H) Ref	1200mm (H) Ref	1800mm (H) Ref
25mm	20	–	193100 ●	–	193300 ●	193400 ●
31mm	19	193900 ●	–	194100 ●	194200 ●	–
31mm	18	–	–	194600 ○	194700 ○	–
50mm	19	195700 ●	195900 ●	–	196000 ●	196200 ●

Suggestions for use: 25mm: plastering and floor screeding; chicken runs. 31mm: protection against the smallest rabbits. 50mm: poultry; general purpose.

Plain Wire (Mild Steel Galvanised)

Size (25kg coils)	Length	Ref
● 5.00mm (6g.)	162m approx.	321000 ■
● 4.00mm (8g.)	254m approx.	321100 ●
● 3.15mm (10g.)	410m approx.	321200 ●
● 2.5mm (12g.)	651m approx.	321300 ●
● 2.0mm (14g.)	1017m approx.	321400 ●
● 1.6mm (16g.)	1590m approx.	321700 ■

Size (5kg coils)	Length	Ref
● 3.15mm (10g.)	82m approx.	323100 ●
● 2.5mm (12g.)	130m approx.	323200 ●
● 2.0mm (14g.)	203m approx.	323300 ●

High Tensile Wire (Galvanised)

Size	Length	Ref
● 3.15mm (10g.)	410m approx.	321500 ●
● 2.5mm (12.5g.)	651m approx.	321550 ●

Barbed Wire (Galvanised)

Our galvanised double strand barbed wire available in 200m with barbs at 100mm centres.

Size	Length	Ref
● 2.5mm	200m approx.	321600 ●
● 1.6mm high tensile	200m approx.	321660 ●



Gripples

Type	Ref
Griple Wire Tensioning Tool	326900 ●
Griple Wire Joiner: Ideal for joining both Mild & High Tensile steel wire 1.6mm-3.2mm & High Tensile barbed wire.	326800 ●
Griple for mild steel barbed wire	326880 ●

● Stock items ■ Check for availability

Galvanised Stock Fencing

(manufactured to BS EN 10223)

- Galvanised wire field fences that are strong, durable & economical
- Wire fencing types 1-4 are coated with Galfan®, highly corrosion resistant zinc and aluminium alloy - Laboratory tests have shown these to last twice as long as ordinary galvanised wires.
- Supplied in 50m as standard or 100m rolls for high tensile.

1 Cattle or Stock Fence (1.15m (Galfan® coated)

Available in medium weight. Eight line wires and uprights 300mm apart.

Type	Wire diameter		Ref
	Top & Bottom	Intermediate	
C8/11/30	3.0mm	2.5mm (50m rolls)	320200 ●

2 Pig Fence (800mm (Galfan® coated)

Eight line wires and uprights 150mm apart (also lamb proof).

Type	Wire diameter		Ref
	Top & Bottom	Intermediate	
Medium C8/80/15	3.0mm	2.5mm (50m rolls)	320400 ●
High Tensile* HT8/80/15	All wires	2.5mm (100m rolls)	320440 ●

3 Sheep Fence (900mm (Galfan® coated)

Six line wires & uprights 300mm apart.

Type	Wire diameter		Ref
	Top & Bottom	Intermediate	
Heavy B6/90/30	4.0mm	3mm (50m rolls)	320700 ●
Medium C6/90/30	3.0mm	2.5mm (50m rolls)	320800 ●

1	12"		3	12"		5	6"	
	230	9"		230	9"		260	10.5"
	200	8"		200	8"		220	8.5"
	180	7"		180	7"		220	8.5"
	150	6"		150	6"		200	8"
	140	5.5"		140	5.5"		180	7"
130	5"			150	6"			
115	4.5"			140	5.5"			
				130	5"			
				115	4.5"			
2	6"		4	6"			6"	
	150	6"		230	9"		100	4"
	140	5.5"		200	8"		80	3.25"
	130	5"		180	7"		80	3.25"
	115	4.5"		150	6"			
	100	4"		140	5.5"			
90	3.5"	130	5"					
75	3"							

4 Forest Fence (1.00m (Galfan® coated)

Seven line wires, uprights 150mm apart.

Type	Wire diameter		Ref
	Top & Bottom	Intermediate	
Medium C7/10/15	3.0mm	2.5mm (50m rolls)	325500 ●

5 Deer Fence (1.90m (Galfan® coated)

Vertical wires 150mm apart for perimeter fencing.

Type	Wire diameter		Ref
	Top & Bottom	Intermediate	
High Tensile 13/190/15 (close uprights)	2.5mm	2.5mm (100m rolls)	325600 ●

Tree and Netting Stakes

Jakcure® treated tree stakes are machine rounded in two sizes 60mm and 75 diameter, and are available in lengths of up to 3m. A minimum of 22.3kg/m² of preservative is used because of presence in the soil of fertilizers and dressings used in the modern orchard.

The Jakcure® treatment process meets fruit growers' specifications, and depth of penetration makes the timber last longer, meaning strong stakes that will provide the best support. All timber is Jakcure® treated softwood guaranteed for 25 years.

When its time to overhaul orchards, and replace any rotten or worn tree stakes, replacing them all with Jacksons stakes will mean you will have good strong stakes that will standing for longer, and this means you will save money by not having to replace them as soon as ordinary non Jakcure® stakes, our stakes are guaranteed for 25 years.

Tree and Netting Stakes

® Tree Stakes (pointed and chamfered)

Length	Dia.	Ref
1.50m	60mm	113500 ■
1.80m	60mm	114400 ■
2.10m	60mm	115200 ■
2.10m	75mm	092100 ■
2.40m	60mm	114500 ■
2.40m	75mm	092200 ■
2.70m	75mm	092300 ■



Buckle Tree Ties

Length	Ref
450mm	100900 ●

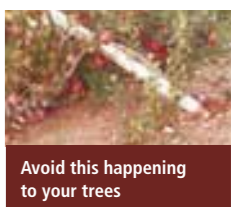

● Stock items ■ Check for availability

Avoid this happening to your trees

Cleft Chestnut Fencing

A simple, fast and cost-effective demarcation solution, our Cleft Chestnut fencing is assembled using best quality galvanised 14 gauge (2mm) wire with 4 strands per row. Pales are cleft, peeled and pointed at one end.



Please note: this Chestnut fencing is not Jakcure® treated timber as Chestnut is a hardwood and therefore cannot be guaranteed for 25 years.



Style A - (2 rows of wire)



Style B - (3 rows of wire)

Approximate spacing: 81 pales in a 9.10m roll. Pales are 75mm spaced. We recommend installation with our machine round Jakcure® posts for long life.

Cleft Chestnut Fencing

Fence Height	Ref
0.90m - Style 'A' 9.10m rolls	291000 ●
1.10m - Style 'A' 9.10m rolls	291600 ●
0.90m - Style 'B' 9.10m rolls	294000 ■
1.10m - Style 'B' 9.10m rolls	294600 ●
1.20m - Style 'B' 4.55m rolls	295500 ●
1.40m - Style 'B' 4.55m rolls	295800 ●
1.50m - Style 'B' 4.55m rolls	296400 ●
1.80m - Style 'B' 4.55m rolls	297000 ■

Intermediate Posts (not chestnut)

Machine round, 75mm diameter. Use at 2.70m intervals.

Fence Height	Post Length	Ref
0.90m	1.50m	091800 ■
1.10m	1.50m	091800 ■
1.20m	1.65m	091900 ■
1.40m	1.80m	092000 ■
1.50m	2.10m	092100 ■
1.80m	2.40m	092200 ■

Corner and End Posts (not chestnut)

Machine rounded 100mm diameter. Use at maximum 45m intervals or corners and changes in direction.

Fence Height	Post Length	Ref
0.90m & 1.10m	1.50m	132100 ■
1.20m & 1.40m	1.80m	132200 ■
1.50m	2.10m	132220 ■
1.80m	2.40m	132300 ■



Due to the erratic price changes in raw material, we have temporarily removed prices from our Good Fencing Guide.

To see our latest prices, view Cleft Chestnut fencing on our website by scanning the QR code.



Inspirational

Many thanks to our customers who have shared their projects with us, without these inspirational images it would be difficult for us to show you the many ways that our products can be used.

If you have any photos of our products in your garden projects we'd love to see them, please email: pics@jacksons-fencing.co.uk

Struts (not chestnut)

Machine rounded, 60mm diameter. Use one on end posts and two on corner and intermediate straining posts.

Fence Height	Post Length	Ref
0.90m & 1.10m	1.35m	114700 ▲
1.20m & 1.40m	1.80m	114900 ■
1.50m	2.10m	115000 ▲
1.80m	2.40m	115100 ▲

Anchor Stakes (not chestnut)

Half round with minimum of 75mm face, pointed and peeled. One per strut 750 - 900mm.

Description	Ref
One per strut 750mm - 900mm	090900 ■

● Stock items ■ Check for availability ▲ While stock lasts

Timber Kissing Gate

A kissing gate is a type of gate which allows the movement of people but not livestock to pass through, keeping them safe and enclosed within an area. This is an alternative to the stile. The term derives from the fact that the gate 'kisses' the stops at the two extremes of its travel.



Timber Kissing Gate

This style of gate has been commonplace in rural areas for years. They are particularly useful in districts populated by older people, where a stile is unsuitable. The kissing gate allows easy access through fences with no climbing necessary.

Specification: The set consists of one 1.05m wide, five bar, Jakcure® treated Uni-Field Gate. Hung on galvanised double band hinges with adjustable bottom eye. The hanging post is 2.10m long x 125mm x 100mm section, shaped four ways. The two slam posts are 1.80m long x 125mm x 100mm section. The 'V' shaped enclosure fence has four rails of 100mm x 38mm section morticed into each side of the corner post, which is also 1.80m long x 125mm x 100mm section. All manufactured from Jakcure® treated softwood. We recommend that all posts should be set in concrete. This unit is suitable for inserting in any type of fence in almost any situation.

Description

Standard timber Kissing Gate complete set

Ref

299900BM ■

Mobility Timber Kissing Gate (wheelchair friendly)

The Mobility Kissing Gate uses the same materials as the standard Timber Kissing Gate, but with a 1.50m gate, which makes it accessible for wheelchair users. Designed and can be installed in accordance with BS 5709:2006

Description

Mobility timber Kissing gate complete set

■ Check for availability

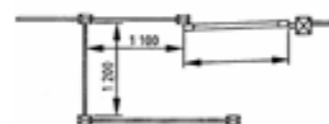

Ref

299800BM ■

Metal Kissing Gate

Our metal kissing gates provide a solid rigid structure designed to allow the flow of pedestrian access in rural locations such as public footpaths or fields. These gates do not allow livestock to pass through keeping them safe and enclosed within a secure area.



Our Galvanised Metal Kissing Gate

This popular self closing six rail Kissing gate is now available manufactured from hot dip galvanised metal, so it will resist rusting for many years and will be virtually maintenance free once installed.

Specification: Dimensions: 1520mm wide, 1170mm high. Manufactured from 25mm x 25mm RHS with four posts 50 x 50mm RHS including adjustable bottom hinge which allows the gate to swing shut either way. Supplied in three sections plus posts and location bars for below ground. All hot dipped galvanised. We recommend that the posts should be set in concrete. This unit is suitable for inserting in any type of fence in almost any situation.

Please note: this gate has been designed to fit into areas where space is minimal but access is required. It is not recommended for public footpaths as the design is under the minimum clear width of 1.1m, stated in BS5709:2018.

Description

Metal Kissing gate complete set

Ref

264600BM ○

RADAR Padlock

Right of way gates can be secured in the closed position with a padlockable drop bolt, this can be used with a RADAR padlock.

Description

RADAR padlock and three keys

Ref

284550BM ■

■ Check for availability ○ Made to order (cannot be cancelled once ordered)



To see our latest prices, view our Kissing Gates on our website by scanning the QR code.

Rights of Way - Stiles

Jacksons' stiles were designed with walkers and the outdoor enthusiast in mind. No more lifting the dog over and getting covered in mud.



Stile with Dog Gate (Rabbit Proof)

Specification (with dog gate):

Description	Ref
Stile Complete With Dog Gate	201700BM ○
Stile (without dog gate)	200700BM ■
Dog gate for attaching to existing stile	201800BM ○

■ Check for availability ○ Made to order (cannot be cancelled once ordered)



Due to the erratic price changes in raw material, we have temporarily removed prices from our Good Fencing Guide.

To see our latest prices, view Cleft Chestnut fencing on our website by scanning the QR code.

Bridle Gates

Description	Ref
Complete Bridle Gate	299770BM ■

Two Way R.O.W. Latch

Two way latch especially suitable for self closing gates where disabled people need to gain access.



Description	Ref
Supplied complete with latch timber packer and activating pin.	271100 ■

Demarcation Fencing

Demarcation devices are a type of fencing which is usually a small structure that simply marks a boundary between two areas, and can take many forms to delineate a boundary.



Diamond Rail Fencing

Specification:

Posts	Ref
0.90m long	200900 ■
1.20m long	201000 ■
Rails	
75mm x 75mm nominal section 2.70m (posts at 1.35m centres)	640600 ●
75mm x 75mm nominal section 1.80m (posts at 1.80m centres)	640300 ●
Galvanised Strap for Diamond Rail	201100 ●

Post and Chain Fencing

Description	Ref
Posts for chain fencing Jakcure® softwood 100mm x 100mm nominal square section, planed shaped top 1.50m	350900 ■
Chain galvanised 50mm x 6mm links spikes in every other link. Price per metre	350600 ●
Hooks galvanised for attaching chain to wooden posts (including screws)	350700 ●

Silver Rail fencing

Specification: Posts are 125mm x 75mm nominal section Jakcure® treated soft wood with rounded tops. Allow 1 post per 2.00m. Rails can be supplied coloured.

Description	Ref
Intermediate Post 1.50m	201200 ■
Corner Posts 1.50m	201300 ○
End Post 1.50m	201500 ■
Rails 6m Galvanised rail (41.5mm diameter including connector)	064000BM ●

● Stock items ■ Check for availability ○ Made to order (cannot be cancelled once ordered)



Timber Bollards

Our metal bollards are available in a variety of shapes and sizes for demarcation purposes, separating pedestrians from traffic or protecting vulnerable points such as corners of buildings that could be accidentally hit by vehicles.



All Jakcure® timber treated bollards are guaranteed for 25 years.

Stress Relieved: 273800, 273900 and 272400 are stress relieved by having a saw cut in the middle of one side allowing the timber to move as it dries out or swells according to the weather, thus avoiding unsightly splits.





- Type**
A - Machine rounded & chamfered
B - Machine rounded & grooved
C - Square with shaped top
D - Square with shaped top & grooved

Timber Bollards

Type - dia/length	Ref	Type - dia/length	Ref
A - 75mm / 0.90m	131400 ▲	A - 125mm / 3.60m	132436 ■
A - 75mm / 1.20m	131500 ▲	A - 150mm / 0.90m	132900 ■
A - 100mm / 0.90m	131900 ■	A - 150mm / 1.20m	133000 ■
A - 100mm / 1.20m	132000 ■	A - 150mm / 1.50m	133100 ■
A - 100mm / 1.50m	132100 ■	A - 150mm / 1.80m	133200 ■
A - 100mm / 1.80m	132200 ■	A - 150mm / 2.40m	133300 ■
A - 100mm / 2.10m	132220 ■	A - 150mm / 3.00m	132930 ■
A - 100mm / 2.40m	132300 ■	A - 150mm / 3.60m	132936 ■
A - 125mm / 0.90m	132400 ■	A - 150mm / 6.00m	132960 ■
A - 125mm / 1.20m	132500 ■	A - 200mm / 6.00m	134400 ▲
A - 125mm / 1.50m	132600 ■	B - 150mm / 0.90m	133900 ■
A - 125mm / 1.80m	132700 ■	B - 150mm / 1.20m	134000 ■
A - 125mm / 2.40m	132800 ■	B - 150mm / 1.50m	134100 ■
A - 125mm / 3.00m	132430 ■	C - 140mm / 0.90m	270100 ■

Type - dia/length	Ref
C - 140mm / 1.20m	270200 ■
C - 150mm / 2.10m	274000 ■
C - 150mm / 2.40m	273900 ■
C - 175mm / 2.10m	272400 ■
C - 175mm / 2.40m	273800 ■
D - 140mm / 1.20m	270220 ■
D - 150mm / 0.90m	270110 ■

Reflectors (complete with fixings)

Colour	Ref
 Amber	360100 ●
 White	360200 ●
 Red	360300 ●

● Stock items ■ Check for availability ○ Made to order (cannot be cancelled once ordered) ▲ While stock lasts

Metal Bollards

Our metal bollards are available in a variety of shapes and sizes for demarcation purposes, separating pedestrians from traffic or protecting vulnerable points such as corners of buildings that could be accidentally hit by vehicles.



Base plated posts are available at an extra cost. Metal bollards are supplied galvanised as standard. Powder coating is extra, please ask for details. Steel bollards 'H' & 'J' are galvanised and polyester powder coated.

Metal Bollards 1.50m

Description	Ref
Domed top 'E' - 178mm x 5mm Dia.	136400 ○
Pyramid top 'F' - 100mm x 100 x 4mm RHS	137400 ○
Gold Dome top 'H' - 178mm x 5mm Diameter	138600 ○
Silver Dome top 'J' - 178mm x 5mm Diameter	138800 ○

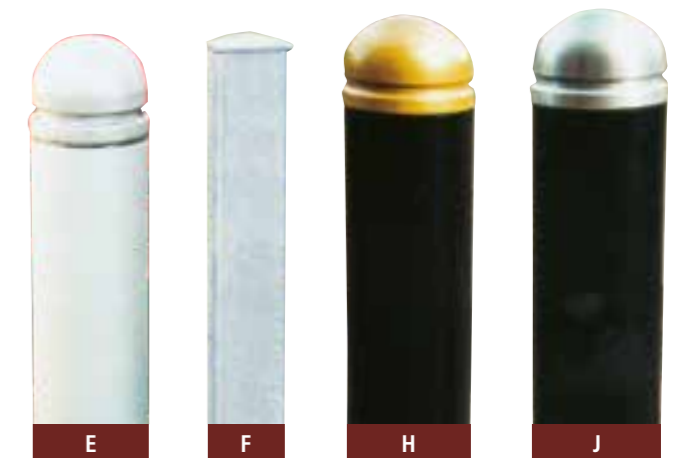

Stainless Steel Bollards

Ideally suited for demarcation and contemporary applications. Stainless Steel bollards are 1.50m long (1m high nominal above ground), 101mm diameter with domed or sloped top. This new stainless steel version represents an impressive low lifetime cost, courtesy of our unique 25 year service life guarantee.

Description	Ref
1.40m x 101mm diameter. type 'K' domed top	138801D ○
1.40m x 101mm diameter. type 'L' sloped top	138801S ○

○ Made to order (cannot be cancelled once ordered)

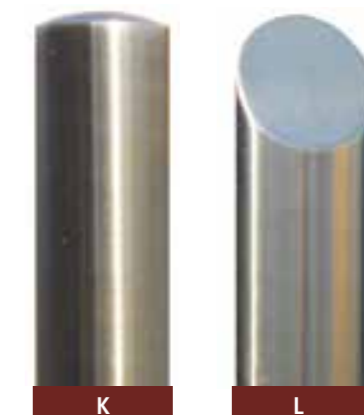

Due to the erratic price changes in raw material, we have temporarily removed prices from our Good Fencing Guide.

To see our latest prices, view our Bollards on our website by scanning the QR code.

Verge Protection Posts, Security Rail & Barriers

Easy to install, our verge protection posts include a metal tube inserted into the bottom of the Jakcure® treated timber post which allows the post to be pushed securely into the ground. If there is a chance the verge posts will be knocked then it may be worth fixing them into the ground with concrete or considering an alternative solution such as timber or metal bollards.



Due to the erratic price changes in raw material, we have temporarily removed prices from our Good Fencing Guide.

To see our Verge Marker Posts prices, view our website by scanning the QR code.

Additional reflectors can be purchased separately in a variety of colours.



Verge Protection Marker Post

The Verge Protection Marker post is 600mm long, 91mm x 91mm section planed all round.



They have a galvanised tube fitted into the bottom of the post for an easy installation, (tube length 450mm) and come complete with two high visibility reflectors (to be fitted on site). Amber, red or white reflectors are available. Please specify. All timber used throughout is superior quality softwood, planed all round and guaranteed for 25 years.

Posts do come complete with reflectors. Installed height 600mm.

Description	Ref
Post with Amber Reflector	200880BM ●
Post with White Reflector	200888BM ●
Post with Red Reflector	200882BM ●

Reflectors

Reflectors can be purchased separately and come complete with fixings / screws.

Description	Ref
 Amber Reflector	360100 ●
 White Reflector	360200 ●
 Red Reflector	360300 ●



Security Rail (or fixed hoop barrier)

Ideal for securing car / garage forecourts in galvanised tube as standard, or coloured tube available (please ask for price).

Description	Ref
60.3mm 2.00m wide x 850mm above ground with 400 mm below. Must be set in concrete. Other sizes available.	581300 ●



The Warden 3.00m - 8.00m (18.00m double)

Constructed of heavily galvanised steel with anti-tamper hinges and provision for high security padlock. Supplied with hinge post and 2 catch posts.

Description	Ref
Single barrier up to 3.00m - 4.40m	581600BM ○
Barriers 4.40m - 6.00m	581601BM ○
Barriers 6.10m - 8.00m	581602BM ○

● Stock items ○ Made to order (cannot be cancelled once ordered)

Cobra-Spike® Security Topping



In areas where security, minimum maintenance, aesthetic appeal, and superior perimeter protection are required, Cobra-Spike® is an ideal solution. Sizes: Supplied in 1.52m lengths. Fixing: Cobra-Spike® comes drilled ready for fixing.



Cobra-Spike® is a registered trade mark of H S Jackson & Son (Fencing) Ltd

Cobra-Spike® Standard

Spikes 110mm long. Pitch of spikes 80mm. Depth of spikes 95mm.

Description	Ref
Galvanised Cobra-Spike®	010988 ●
Coated Cobra-Spike®	010990 ●

High Tensile Barbed Wire

Our galvanised barbed wire. Twin strand made to B.S.S.

Length	Ref
200m x 1.6mm	321660 ●

Danger Signs

These should be used every 10m and change of direction.

Description	Ref
Danger sign	329330 ●



● Stock items ■ Check for availability
○ Made to order (cannot be cancelled once ordered)

Security Comb



Sizes: Supplied in 1.80m lengths. The double row of spikes is 40mm wide and depth of spikes 25mm. Fixing: Security Comb comes drilled ready for fixing.

Security Comb

Description	Ref
Galvanised Security Comb	010800 ●
Galvanised & Coated Security Comb	910800 ○

To see our latest prices, view our Security Toppings on our website by scanning the QR code



Barbed Tape



Flat Wrap Barbed Tape

Easy to install. Does not hang outside your boundary.

Coil Height	Approx. Coil Length	Ref
500mm	12.00m	329000 ●
700mm	14.00m	329100 ■
900mm	14.00m	329200 ■

Rota-Spike® Security Topping



Sizes: Supplied in 6m lengths (shorter lengths available). Inner tube 41.5mm diameter. Blades 90mm long rotating on outer tube. 48.3mm diameter. Brackets at 3m centres when vertical and 2m when horizontal. Fixing: Brackets for fixing.

Rota-Spike®

Description	Ref
6.0m galvanised rail	064000BM ●
Rota-Spike® for 6.00m	010994 ●
A: End wall bracket (248 x 65 x 100mm long)	019991 ●
B: Intermediate bracket (248 x 65 x 100mm long)	010998 ●
Mitre corner	019992 ●



Viper-Spike® Security Topping



Sizes: Viper 1, 1.10m long with bottom bar. Can be fitted either vertically or horizontally. Viper 3, 150mm deep, 200mm wide.

Ideal for preventing intruders from climbing drainpipes, cables, etc. Fixing: Viper-Spike comes drilled with 12mm holes ready for fixing. Other uses: Viper-Spike® is ideally suited to protect electricity masts and other important installations.



Viper 3

Viper-Spike® Security Topping

Our galvanised barbed wire. Twin strand made to B.S.S.

Description	Ref
Viper 1 (1.10m lengths)	010989 ●
Viper 3 (150mm x 200mm x 150mm)	010993 ●

Razor Wire Concertina

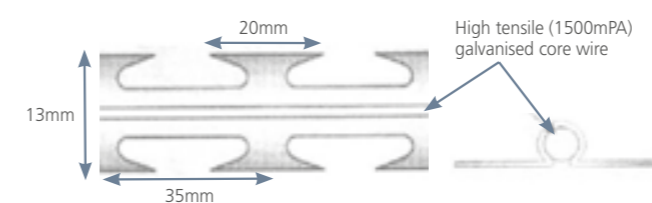

● Stock items



Features: A wide central steel band which provides additional rigidity to the coil. The blades are substantial and effective: 20mm tip to tip. 35mm centre to centre.

Coil diameter	450mm	730mm	980mm
Approx. coil length	8.00m	10.00m	10.00m
Extended diameter	400mm	620mm	820mm
Spirals turns per coil	54/55	54/55	54/55
Clips per spiral	3	5	5
Reference	327500 ●	327600 ●	327700 ●

Anti-Climb Express® Temporary Fencing



Image is for illustrative purposes as we no longer sell concrete feet for temporary fencing



*Thermoplastic foot replaces previous plastic foot filled with concrete.



Anti-Climb Express® Temporary Fencing panels are constructed from galvanised tube frames with welded mesh infill. They are 2.00m high x 3.50m wide, clad with 38mm x 253mm mesh. Standard panels have 38mm uprights with a 25mm top & bottom rail. Heavy duty panels have a 38mm frame throughout. It is easy to create a gate at any point on the perimeter.

Express panels are economical as they can be used time after time. Panels stack easily and can be delivered accompanied by fork lift for easy distribution. They are surprisingly light and easy to handle. It is possible to erect four metres a minute.

Anti-Climb Express® Temporary Fencing Panels

Temporary Fencing	Ref
Anti-Climb Heavy Duty (10x min. delivery qty)	050010 ●
Anti-Climb Standard (10x min. delivery qty)	050008 ●
Pedestrian gate 2.00m x 1.00m wide	050200 ●
1.10m high crowd control barrier	050009 ■
Footings	
Thermo Plastic Foot*	050166 ●
Double Metal Foot	050171 ■
Fence Stabiliser	050039 ●
Accessories	
Fence coupler - 2 per panel standard	050035 ●
Gate Hinge	050036 ●
Anti-Lift Device	050200 ●

Express panels do not qualify for the Jacksons 25 year service life guarantee as they are a temporary product.

● Stock items ■ Check for availability

Galvanised Tubular Fencing



Our galvanised tubular fencing system works with both chain link and welded mesh cladding. The tubular construction makes it far stronger than old fashioned 'rusty' angle iron or heavy concrete post systems, it also makes it less vulnerable to vandals. Being tubular, it also eradicates the chances of the top rails sagging, which is a common problem with old systems, so it stays looking good for much longer. Extra security can be added by fixing vertical or cranked extensions for barbed wires or tapes on to the top of the system.

On the next pages we show the six systems we offer for tubular fencing for both welded mesh and chain link cladding.

Please ask our sales advisors for help with any technical details you require, call 0800 41 43 43.

Jacksons Fencing is a Secured by Design Licensed Company with products which meet technical standards endorsed by the UK Police Service.

To see our latest prices, view our Express Fencing on our website by scanning the QR code



Galvanised Tubular Fencing System

System 1

Tubular fencing system without a top rail, in medium and heavy duty.

Heavy and medium grade tubular posts with straining posts and struts. Intermediate posts are supplied with line wire clips and a post cap (see detail). Straining posts are supplied with struts (for use at ends, corners and changes in direction), stretcher bars and winders. Suitable for domestic installations, dog runs etc.

System 2

Tubular fencing system without a top rail, heavy duty with posts vertically extended for 3 rows of barbed wire.

Heavy grade tubular posts with straining posts and struts. Intermediate posts are supplied with line and barbed wire clips and a post cap (see detail). Straining posts are supplied with struts as required, stretcher bars and winders (see detail). Suitable for industrial fencing with minimum security applications.

System 3

Tubular fencing system with a top rail and heavy duty posts. (Will not suffer deformation when climbed over).

Intermediate posts are supplied with line wire clips and a post cap to locate the top rail (see detail). Straining posts are supplied with stretcher bars and winders, and fittings for the top rail (for use at ends, corners and changes of direction). Suitable for domestic installations where the fence will be tested and the long term look of the fence is important.

- Galvanised tubular fencing system for both chain link and welded mesh cladding
- Tubular construction for extra strength - less vulnerable to vandalism
- Supersedes old fashioned 'rusty' angle iron or heavy concrete post systems
- No sagging with extra strength from the top rail - stays looking good for much longer
- Extra security options - vertical or cranked extensions for barbed wires or tapes

System 4

Tubular fencing system with a top rail & heavy duty posts & vertical extensions for 3 rows of barbed wire.

Intermediate posts are supplied with line wire clips and a post cap to locate the top rail and high tensile barbed wire (see detail). Straining posts are supplied with stretcher bars, winders and fittings for the top rail, as well as winders for the barbed wire (for use at ends, corners and changes of direction). Suitable for quality industrial installations where the fence will be tested and the long term look of the fence is important.

System 5

Tubular fencing system with a top rail, heavy duty posts and cranked intermediate extensions for 3 rows of barbed wire with struts for securing cranked extensions on end and corner posts.

Intermediate posts are supplied with line wire clips (see detail) and a post cap to locate the top rail and high tensile barbed wire. Straining posts are supplied with stretcher bars, winders, and fittings for the top rail, as well as winders for barbed wire (for use at ends, corners and changes of direction). Suitable for quality industrial installations where the fence will be tested and the long term look of the fence is important.

System 6

Tubular fencing system with a top rail, heavy duty posts and 'Y' extensions for 6 rows of barbed wire.

Intermediate posts are supplied with line wire clips (see detail) and a post cap to locate the top rail and high tensile barbed wire. Straining posts are supplied with stretcher bars, winders and fittings for the top rail, as well as winders for barbed wire (for use at ends, corners & changes of direction). Suitable for high security installations, where the fence will be tested & the long term look of the fence is important. In addition to six rows of barbed wire, concertina razor wire can be fixed in the 'Y' to make an almost impenetrable barrier.

Post Setting etc.

Intermediate posts should be set at 3.00m centres, straining posts should be set at all dramatic changes of direction and levels, with a maximum 100m for straight runs or 69m if the fence has no top rail. All straining posts should be set in concrete and intermediate posts if it is a security fence.

Posts should be set at the following depths:
 Fence heights up to 1.40m - 600mm in the ground
 Fence heights from 1.50m to 3.05m - 750mm - 800mm in the ground
 Fence heights over 3.05m - 800mm in the ground



Details on Systems 1 - 6

Drawings A to K below correspond to the circled figures in the diagrams for Tubular Fencing Systems 1 to 6 above.

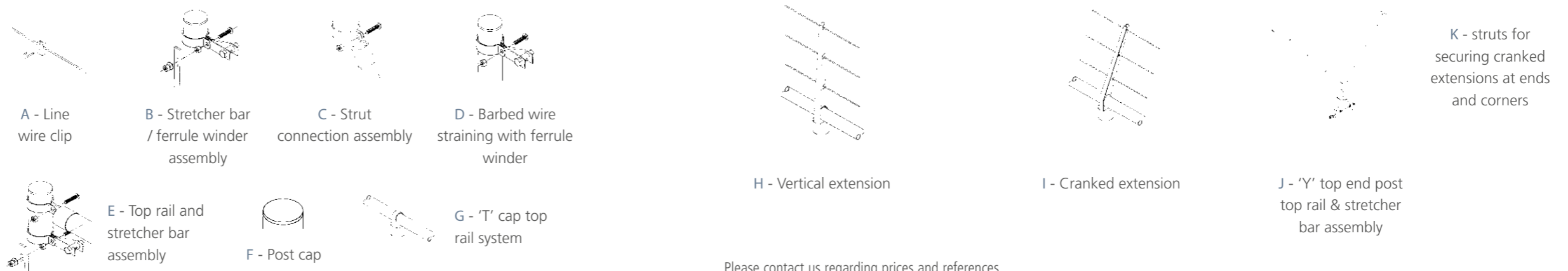

Please contact us regarding prices and references.

System 1 Medium

Fence Height	Intermediate posts		
	Ref	GALV	PPC
0.90m	061509BM		
1.20m	061512BM		
1.40m	061514BM		
1.80m	061518BM		

Top Rail

	Ref	GALV	Ref	PPC
6m with connector	064000BM		064000BM	

System 1 Heavy

Fence Height	Intermediate posts			End posts			Corner 2 way posts		
	Ref	GALV	PPC	Ref	GALV	PPC	Ref	GALV	PPC
0.90m	061609BM			062609BM			063609BM		
1.20m	061612BM			062612BM			063612BM		
1.40m	061614BM			062614BM			063614BM		
1.80m	061618BM			062618BM			063618BM		
2.00m	061620BM			062620BM			063620BM		
2.40m	061624BM			062624BM			063624BM		
2.75m	061627BM			062627BM			063627BM		
3.05m	061630BM			062630BM			063630BM		
3.60m	061636BM			062636BM			063636BM		

System 2

Fence Height	Intermediate posts			End posts			Corner 2 way posts		
	Ref	GALV	PPC	Ref	GALV	PPC	Ref	GALV	PPC
1.80m	061718BM			062718BM			063718BM		
2.00m	061720BM			062720BM			063720BM		
2.40m	061724BM			062724BM			063724BM		
2.75m	061727BM			062727BM			063727BM		
3.05m	061730BM			062730BM			063730BM		
3.60m	061736BM			062736BM			063736BM		

System 3

Fence Height	Intermediate posts			End posts			Corner 2 way posts		
	Ref	GALV	PPC	Ref	GALV	PPC	Ref	GALV	PPC
0.90m	061109BM			062109BM			063109BM		
1.20m	061112BM			062112BM			063112BM		
1.40m	061114BM			062114BM			063114BM		
1.80m	061118BM			062118BM			063118BM		
2.00m	061120BM			062120BM			063120BM		
2.40m	061124BM			062124BM			063124BM		
2.75m	061127BM			062127BM			063127BM		
3.05m	061130BM			062130BM			063130BM		
3.60m	061136BM			062136BM			063136BM		



System 4

Fence Height	Intermediate posts			End posts			Corner 2 way posts		
	Ref	GALV	PPC	Ref	GALV	PPC	Ref	GALV	PPC
1.80m	061318BM			062318BM			063318BM		
2.00m	061320BM			062320BM			063320BM		
2.40m	061324BM			062324BM			063324BM		
2.75m	061327BM			062327BM			063327BM		
3.05m	061330BM			062330BM			063330BM		
3.60m	061336BM			062336BM			063336BM		

System 5

Fence Height	Intermediate posts			End posts			Corner 2 way posts			2 way posts		
	Ref	GALV	PPC	Ref	GALV	PPC	Ref	GALV	PPC	Ref	GALV	PPC
1.80m	061218BM			062218BM			063218BM			064218BM		
2.00m	061220BM			062220BM			063220BM			064220BM		
2.40m	061224BM			062224BM			063224BM			064224BM		
2.75m	061227BM			062227BM			063227BM			064227BM		
3.05m	061230BM			062230BM			063230BM			064230BM		
3.60m	061236BM			062236BM			063236BM			064236BM		

System 6

Fence Height	Intermediate posts			End posts			Corner 2 way posts			2 way posts		
	Ref	GALV	PPC	Ref	GALV	PPC	Ref	GALV	PPC	Ref	GALV	PPC
1.80m	061418BM			062418BM			063418BM			064418BM		
2.00m	061420BM			062420BM			063420BM			064420BM		
2.40m	061424BM			062424BM			063424BM			064424BM		
2.75m	061427BM			062427BM			063427BM			064427BM		
3.05m	061430BM			062430BM			063430BM			064430BM		
3.60m	061436BM			062436BM			063436BM			064436BM		

Key: GALV = Hot Dipped Galvanised. PPC = Polyester Powder Coated.

Chain Link Gates

Chain Link Gates - suitable for domestic & heavy duty fencing using the Galvanised Tubular System. The standard chain link gates are made for 980mm opening and are 50mm shorter than the fence height.



They are right or left hand hanging and clad with galvanised coated chain link, also available in a green finish. The framing is made from 42mm diameter galvanised tube. The gates come ready for hanging, complete with hinge pins, and bolts for attaching to the end strainer.



Single or Double-leaf Gates for Industrial Use

Single or double-leaf gates can be supplied for industrial use to almost any specification and degree of security. Gates can be made to suit various conditions and to hang in line between posts for 90° opening or behind the posts for 180° openings and are manufactured 0.91m wide.

- Galvanised tubular system gates with both chain link and welded mesh cladding.
- Suitable for domestic or heavy duty fencing.
- Galvanised finish with optional polyester powder coating.
- Single or double leaf for industrial use.
- Security options - as with fencing system extensions for barbed wires or tapes.
- Tubular construction for extra strength - less vulnerable to vandals.

Fence Height	Gate Height	Plastic Coated Infill		Galvanised Infill	
		Ref		Ref	
0.90m	0.86m	309610		309661	
1.20m	1.17m	309710		309771	
1.40m	1.32m	309810		309881	
1.80m	1.78m	309910		309991	
2.00m high tennis court gate, made in a frame for easy installation fitted with an integral key lock.				051020BM	



Welded mesh cladding



To see our latest prices, view our Chain Link gates on our website by scanning the QR code

Items to Consider

- Single or double leaf.
- Height of gate frame.
- Width of opening.
- Opening inwards or outwards.
- Opening arc 90° or 180°.
- Gate posts (round).
- Chain link infill available in plastic covered or galvanised wire.

Hinge Pack

With bolts for attaching to end strainer posts. Included free of charge with gates. Please specify type required.

Description	Ref
Fittings kit for gates, included free of charge with gates.	307777BM

Chain Link Galvanised - 50mm Mesh

Suggestions for use:-

- The galvanised tubular system on pages 143 - 147 gives greater support and strength to the chain link & prevents deformation of the top.
- 2.5mm Galvanised and 1.7/2.5mm are suitable for general domestic, 2.24/3.15mm for site compounds and tennis courts - 2.75m high.
- Galvanised is best for dogs, 2.5mm for most breeds, but 3mm should be used for the stronger and larger breeds.
- For heavy industrial use 3mm or 3.5mm galvanised or PVC coated, 2.5/3.55mm, 3.0/4mm or 3.5/4.75mm according to the situation.



Chain Link Mesh - Galvanised Finish

Chain Link Mesh - PVC Finish

Roll Height			0.9m	1.2m	1.4m	1.8m	2.0m	2.4m	2.75m	3.05m
Standard No. of Line Wires			2	3	3	3	3	4	5	5
Wire Size	Gauge	Length	Ref	Ref	Ref	Ref	Ref	Ref	Ref	Ref
2.5mm	12½g	25m	300100 ●	300200 ●	300300 ●	300400 ●	—	—	—	—
2.5mm	12½g	12.5m	—	—	—	—	311700 ●	307000 □	305000 □	—
3.0mm	10½g	25m	300500 ●	300600 ●	300700 ●	—	—	—	—	—
3.0mm	10½g	12.5m	—	—	—	300800 ●	315300 □	303700 ●	305200 □	303800 □
3.55mm	9½g	12.5m	305900 □	306100 □	306900 □	315700 □	316100 □	316500 □	316900 □	317300 □

Note: Separate galvanised line wire on page 128. Chain Link fencing conforms to B.S. 1722 part 1, galvanising conforms to BS EN 10223. Line wire is supplied with each roll. Non stock items 21-35 days delivery. Free fence erection instructions available upon request.

Chain Link Galvanised PVC Coated - 50mm Mesh

Roll Height			0.90m	1.20m	1.40m	1.80m	2.00m	2.40m	2.75m	3.05m
Standard No. of Line Wires			2	3	3	3	3	4	5	5
Wire Size	Length	Ref	Ref	Ref	Ref	Ref	Ref	Ref	Ref	Ref
1.7/2.5mm (Green only)	25m	300900 ●	301000 ●	301100 ●	301200 ●	—	—	—	—	—
1.7/2.5mm (Green only)	10m	303300 ●	303400 ●	303500 □	303600 ●	—	—	—	—	—
2.24/3.15mm 13.5 /10.5g	25m	301300 ●	301400 ●	301500 ●	301600 ●	—	—	—	—	—
2.24/3.15mm 13.5 /10.5g	12.5m	—	—	—	—	305500 □	307500 □	305400 □	305700 □	—
2.5/3.55mm 12 /9.5g	12.5m	302912 ●	303012 ●	303112 □	303212 ●	304500 □	306300 □	305600 ●	306500 □	—
3.0/4.0mm 10/2/8g.	12.5m	309500 □	310000 □	312100 □	304000 ●	306700 □	304100 ●	307100 □	304200 □	—
3.55/4.75mm 9.5/6.5g.	12.5m	321900 □	322000 □	322100 □	307900 □	308000 □	308100 □	308200 □	308300 □	—

● Stock items □ Supplied to order (Cannot be cancelled once ordered).



Heavy Welded Mesh Galvanised Finish

Heavy Welded Mesh PVC Finish

Tennis Court Fence

Tennis court fence 2.75m high constructed of tubular posts 60.3mm diameter, with a galvanised top rail and struts of 41mm diameter complete with tubular formed gate. The whole court clad with plastic coated chain link 50mm mesh, 3.15mm overall, with 2.24mm galvanised core wire complete with plastic coated line and tying wires.

- Galvanised tubular system 3 Tennis Court Surrounds with both chain link and welded mesh cladding.
- Galvanised finish with optional polyester powder coating (at extra cost).
- Tubular construction for extra strength - less vulnerable to vandals.
- Comes complete with plastic coated line and tying wires.

Single or Double Court Fencing

Description	Single Court 18m x 36m		Double Court 34m x 36m	
	Qty		Qty	
3.5m long galvanised corner posts complete with fittings & struts.	4		4	
3.5m long galvanised intermediate posts.	32		44	
Top Rail 6m Galvanised top rail with connectors.	18		24	
Tennis Court Gates and frame Galvanised 1m wide x 2m high complete with Galvanised chain link infill and key lock.	1		2	
Chain Link 12.5m rolls Green PVC coated with galvanised core wire, 2.75m high, 3.15/2.24mm gauge.	9		12	
Tying wire 1kg. coils 2mm PVC coated.	2		2	

For prices on tennis court kits see our separate price list, or call us for a quote on any variations to the court sizes above.

● Stock items □ Supplied to order (Cannot be cancelled once ordered).

Heavy Welded Mesh - Galvanised Finish

Height	Mesh	Wire Size	Length of Roll	Ref
0.90m	50x50mm	2.5mm	25m	520000 ●
0.90m	50x50mm	3.0mm	25m	520100 ●
1.20m	50x50mm	2.5mm	25m	520400 ●
1.20m	50x50mm	3.0mm	25m	520500 ●
1.80m	50x50mm	2.5mm	25m	521500 ●
1.80m	50x50mm	3.0mm	25m	521600 ●
1.80m	75x25mm	3.0mm	25m	521700 □
2.40m	50x50mm	2.5mm	12.5m	522100 ●
2.40m	50x50mm	3.0mm	12.5m	522200 ●
2.67m	75x25mm	3.0mm	12.5m	522999 □
2.40m	75x25mm	3.0mm	12.5m	522300 □

Heavy Welded Mesh - Green PVC Finish

Height	Mesh	Wire Size	Length of Roll	Ref
0.90m	50x50mm	3.1/2.5mm	25m	520300 ●
1.20m	50x50mm	3.1/2.5mm	25m	520800 ●
1.80m	50x50mm	3.1/2.5mm	25m	521900 □
0.90m	50x50mm	3/3.5mm	25m	522750 □
1.20m	50x50mm	3/3.5mm	25m	522760 □
1.80m	50x50mm	3/3.5mm	25m	522780 □
2.40m	50x50mm	3/3.5mm	25m	522800 □

Heavy Welded Mesh - Black PVC Finish

Height	Mesh	Wire Size	Length of Roll	Ref
0.90m	50x50mm	3/3.5mm	25m	522759 □
1.20m	50x50mm	3/3.5mm	25m	522769 □
1.80m	50x50mm	3/3.5mm	25m	522789 □
2.40m	50x50mm	3/3.5mm	25m	522809 □

Our tubular system works equally well with welded mesh as an alternative cladding. Galvanised to BS EN 10223. For Line wire see page 128.

Light Welded Mesh

Galvanised rolls of 30m or 6m welded mesh are Ideal for pet cages, puppy runs and aviaries. Other uses include greenhouse staging for making trays baskets and seedling guards.

There are literally hundreds of other uses to which people put this adaptable mesh. Height is 900mm.

Mesh (mm)	Gauge	6m Roll Ref	30m Roll Ref
13 x 13	19	364000 ●	362100 ●
13 x 25	19	364100 ●	362700 ●
25 x 25	16	364400 ●	362400 ●

Chain Link Accessories for Timber and Concrete Posts

If you decide not to use our complete Tubular Chain Link System (page 143 onwards) you will need special fittings to use with timber and concrete posts. The accessories listed here will provide you with the necessary materials to help you install a chain link, welded mesh, plain or barbed wire fence. Should you have any difficulty in deciding which materials you need, please contact our sales team, who are always willing to assist you.

Stretcher Bar Kits, Stretcher Bars, Angle Cleats, Eyebolts and Adaptors for chain link fencing when attached to wooden or concrete posts. All hot dip galvanised.

1 Stretcher Bar Kits

Height	No. of Angle Cleats, Eyebolts, Adaptors & Hex bolts per bar	Ref
0.90m	2	301700BM ●
1.20m	3	301800BM ●
1.40m	3	301900BM ●
1.80m	3	302000BM ●

2 Stretcher Bars - Hot Dip Galvanised

Size	Ref
900mm x 5mm 2 holes	335030 ●
1050mm x 5mm 2 holes	335730 ●
1200mm x 5mm 3 holes	335130 ●
1400mm x 5mm 3 holes	335230 ●
1500mm x 5mm 3 holes	335830 ●
1800mm x 5mm 3 holes	335330 ●
2000mm x 5mm 3 holes	335930 ●
2100mm x 5mm 3 holes	335430 ■
2400mm x 5mm 4 holes	335530 ●
2750mm x 5mm 5 holes	335630 ●
3000mm x 5mm 5 holes	334830 ●

3 Bolts for Stretcher Bars with 2 Nuts Galvanised

Size	Ref
M8 x 40 (supplied in 100s)	336000 ●

4 Galvanised Angle Cleats

Size	Ref
40mm x 40mm x 5mm	336100 ●
50mm x 50mm x 6mm	336200 ●

5 Galvanised Eye Bolts

(Fully threaded welded eye with 2 nuts & washers)

Size	Ref
200mm x 10mm	344000 ●
300mm x 10mm	341800 ●
300mm x 12mm	341700 ●



6 Galvanised Loop Adaptors

Size	Ref
10mm eye bolts	341880 ●

7 8 9 Strainers Galvanised

Size	Ref
G - Ratchet - Heavy duty (7)	342000 □
H - Radisseur - Large (8)	341900 □
I - Ferrule (9)	342400 ●

10 Barbed Wire Stays

Size	Ref
710mm x 30mm x 6mm. Galvanised & notched for 3 rows of barbed wire.	342300 ●

Tying Wire 1kg Coils

Size	Ref
16g.(1.6mm), Galvanised, 62m	338000 ●
14g.(2.0mm), Green P.V.C. Coated, 70m	338100 ●

Line Wire PVC Coated Green

Size	25kg Ref	26m Ref
2.24/3.15mm - 710m	339400 ●	337400 ●
2.50/3.55mm - 550m	339500 ●	337500 ●
3.00/4.00mm - 420m	339600 ●	337600 ●
3.55/4.75mm - 280m	339700 ●	337700 □

● Stock items □ Supplied to order (Cannot be cancelled once ordered).
■ Check for availability.

Fixing Tools & Miscellaneous

1 Jakclips

The simplest method for square posts- 2 clips to fix each side of the panel to non-slotted square post.

Size	Ref
Fixing set: 4 x self screw Jakclips, 8 x 50mm galvanised nails, 2 x 65mm galvanised nails for post caps (plus 1 spare).	645000 ●

2 Jakcure® Timber Spur Posts

Posts are 100mm x 100mm nominal section with 2 x 10mm holes drilled for bolting to the post. Posts are set 600mm into the ground.

Size	Ref
Standard stock size. 1500mm. For bolts see below.	756310 ■

3 Cement and Ballast

Size	Ref
20kg Bag Post Fixing Mix	648071 ●
25kg Ballast Bag	648110 ●
25kg Master Crete (Extra rapid cement) Bag	648220 ●
25kg Standard Cement Bag	648200 ●

4 Bolts & Nuts Cup Square Galvanised

Length	M8 Ref	M10 Ref	M12 Ref
50mm	803900	805600	807300
55mm	804000	805700	-
65mm	804100 ●	805800 ●	807500
75mm	804300 ●	806000 ●	807600 ●
90mm	804500 ●	806200 ●	-
100mm	804600 ●	806300 ●	807800 ●
110mm	804700 ●	806400 ●	807900 ●
130mm	804800 ●	806500 ●	808000
140mm	-	806600 ●	-
150mm	804900 ●	806700 ●	808100
160mm	-	806800 ●	808200
180mm	805000 ●	806900 ●	808300
220mm	-	807100 ●	808500

5 Countersunk Supascrews Stainless Steel

Length	Size	Per 200	Per 10
40mm	4mm	809000 ●	809010 ●
45mm	5mm	809100 ●	809110 ●
50mm	5mm	809200 ●	809210 ●
65mm	5mm	809300 ●	809310 ●
75mm	5mm	809400 ●	809410 ●

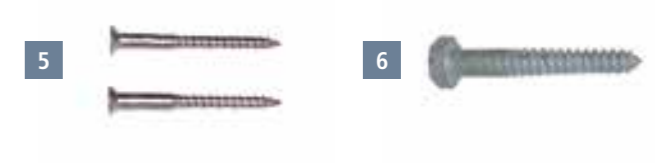

6 Coach Screws Hex Head

Chamfered head Gimlet Point.

Length	M8 Ref	Ref
65mm	810500	-
75mm	810600 ●	-
90mm	-	811100
100mm	-	811200 ●

7 Roofing Bolts - Galvanised

Diam.	Length	Ref per 100
M8	40mm	813000 ●

8 Bolts & Nuts Cup Square Galvanised

Bolt	O.D. mm	Thickness mm	Ref per 100	Ref per 10
M8	21	2.0	811800 ●	812300 ●
M10	24	2.0	811900 ●	812400 ●
M12	28	2.5	812000 ●	812500 ●

● Stock items ■ Check for availability.

Stainless Steel Nails for Palisade and Featherboard Fencing

Length	Approx Count per kg.	Ref 5kg. box	Ref 1kg. bag
50mm	441	800750 ●	800710 ●

1 Galvanised Staples

Size	Approx Count per kg.	Ref 20kg. Carton	Ref 5kg. Tub	Ref 1kg. Tub
20 x 2.00mm	1079	801020 ●	801050 ●	801010 ●
30 x 3.55mm	226	801120 ●	801150 ●	801110 ●
40 x 4.00mm	136	801220 ●	801250 ●	801210 ●

2 Galvanised (Barbed) Staples

Size	Approx Count per kg.	Ref 20kg. Carton	Ref 5kg. Tub	Ref 1kg. Tub
30mm x 3.15mm	250	328620 ●	328650 ●	328610 ●

3 Wire Nails (Galvanised Wire)

Length	Approx Count per kg.	Ref 25kg.	Ref 5kg. Tub	Ref 1kg. Tub
50mm	441	800100 ▼	800150 ▼	800110 ▼
65mm	216	800400 ●	800450 ●	800410 ●
75mm	145	800200 ●	800250 ●	800210 ●
100mm	79	800300 ●	800350 ●	800310 ●
125mm	42	800500 ●	800550 ●	800510 ●
150mm	31	800600 ●	800650 ●	800610 ●

4 Resin Anchor

Description	Ref
Tube of polyester resin for anchoring studding	070007

5 Resin Applicator

Ref
070009

6 Studding

Lengths of threaded galvanised metal rod studding including 7 nuts & washer per metre.

Size	Ref
M8	070008
M10	070010
M12	070012
M16	070016

7 Steel Locking Bars

In Galvanised finish.

Size	Ref
300mm	354000 ●

8 Arris Rail Repair Bracket

In galvanised finish.

Size	Ref
300mm	420300 ●

9 Heavy Cross Bolt

In galvanised finish.

Size	Ref
450mm	352400 ●

10 Brenton Pattern Galvanised Bolts

Size	No. of Screws/Bolts	Ref
150mm	4/4	344900 ●*
200mm	4/4	345000 ●*
250mm	4/4	345100 ●*
300mm	4/4	345200 ●*

● Stock items ▼ While stocks last * Includes bolts and screws

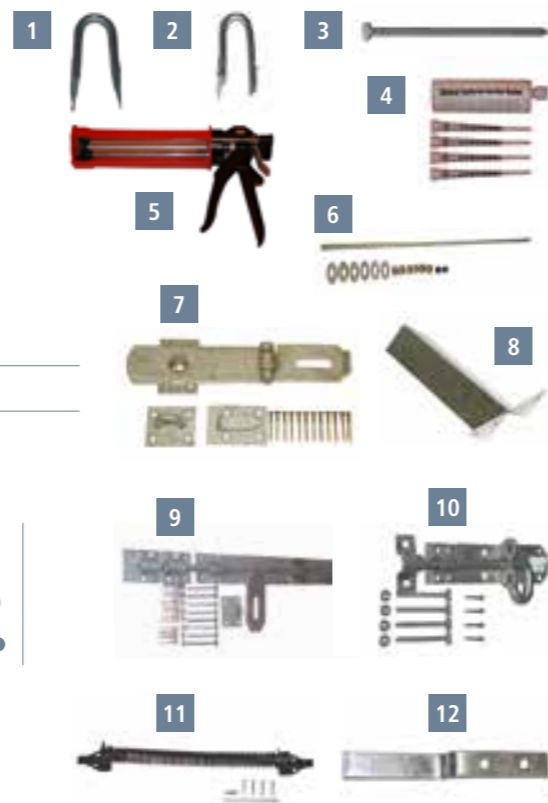

11 Gate Return Spring

Epoxy Black.

Size	Ref
250mm	346800 ●*

12 Lift Gate Hook

Description	Ref
With coach screws to take 38mm rails.	420400

13 14 Padlocks

Description	Ref
Padlock 60mm. Defiant 6 lever padlock. 12mm shackle dia.	357100 ●
RADAR padlock (3 keys) p. 130	284550BM

15 Monkey Tail Bolt

Size	Ref
450mm x 16mm	353400 ●

16 Tee Hinges

Length of Tail	Ref
300mm	344500 ●*
400mm	344600 ●*
450mm	344700 ●*
600mm	344800 ●*

1 Ring Latches Galvanised

Description	Ref
Two ring handles, Heavy - 125mm	350300 ●*
Two ring handles, Extra Heavy - 175mm	355000 ●*

2 Automatic Latch

Description	Ref
Heavy Duty Galvanised	350400 ●*

3 Pad Bolt

Description	Ref
Oval Galvanised - 100mm	351300 ●*

4 Cabin Hook Galvanised

Description	Ref
100mm	351550 ●*
150mm	351660 ●*

5 Ring Gun

Description	Ref
Automatic Ring Fastener Gun. Very fast method of fastening wire netting and chain link to support wires	410400 ●

6 Ring Fasteners

For use with ring gun in image 5 in packs of 1000.

Description	Ref
Galvanised	410500 ●
Stainless Steel	410550 ●

7 Welded Mesh Clip Tool

Description	Ref
Fast method for attaching welded mesh providing a high level of security.	523100 ●

8 Welded Mesh Clips

Description	Ref
Stainless steel clips in packs of 1443.	523000 ●

9 Hook & Band Hinge

Description	Ref
Price per pair. Cranked folded eye 400mm	350200 ●*

10 Adjustable Hook & Band Hinge

Bent Hinge (10A) Size	Ref
400mm per pair	350550 ●*
Boxed Hinge (10B) Size	Ref
500mm per pair	350800 ●*
700mm per pair	351770 ●*



11 Heavy Reversible Hinges

Size	Ref
620mm x 19mm	352900 ●*
780mm x 19mm	353300 ●*
930mm x 19mm	353000 ●*

12 Fencing Pliers

Description	Ref
Invaluable aid to wire and fencing work	370700 ●

13 Wire Cutters

Description	Ref
A For cutting up to 3.15mm H.T. plain wire	334000 ●
B For cutting and twisting up to 3.15mm H.T. or 4mm mild steel wire	334100 ●
C For cutting mild steel strand 6.5mm High Tensile steel rope 180kg/mm ² 5.0mm Steel rod 66kg/mm ² 4.0mm Spring wire 180kg/mm ² 2.5mm	334200 ●

● Stock items * Includes bolts and screws



1 Claw Hammer

Description	Ref
A strong Claw Hammer with wooden handle	371200 ●

2 Wire Tying Tool

Description	Ref
Complete with rubber handle	349700 ●

3 Wire Tensioning Tool

Description	Ref
Wire Tensioning Tool	346900 ●

4 Wire Ties Galvanised

Wire ties are the most efficient method of tying up bags, sacks, bundles and chain link to the top rail.

Description	Ref
100mm Galvanised per 1000	348900 ●
200mm Galvanised per 1000	563492 ●

5 Post Level

Sturdy, high-impact POSTRITE construction. Three durable adjustment free acrylic vials to read plumb and level. Use when establishing plumb or level on fences, posts etc.

Description	Ref
Post Level	400800 ●

6 'Monkey' Hole Borer

Description	Ref
150mm diameter	392000 ●
225mm diameter	392100 ●

7 Post Driver

For driving home wooden posts, stakes, angle irons etc. with no hole digging, ramming or damage to posts.

Description	Ref
No. 5 for posts up to 120mm diameter	400600 ●
No. 6a for posts up to 146mm diameter (two handles)	400700 ●

8 Grubbing Mattock

Description	Ref
5lb. (Head only)	347700 ●

9 Hickory Mattock & Pickaxe Handle

Size	Ref
900mm	347800 ●

10 Sledgehammer

Size	Ref
10lb.	347200 ●

● Stock items



11 Square Rammer

Description	Ref
Tubular handle. 10lb. Head	346200 ●

12 Grafting Spade

Description	Ref
Grafting Spade	401500 ●

13 Spade Rabbiting - Telecom

Description	Ref
1.70m tubular steel handle. Size 124mm x 320mm	346700 ●

14 Heavy Duty Shovholer Hole Digger

Description	Ref
50% quicker and easier than using a spade	401400 ●

15 Crowbar Chisel & Point

Description	Ref
1.50m	346300 ●

16 Post Maul

Description	Ref
Fibre glass handle	345330 ●

Index

A	Access Control 108-111	Access Restrictors 138-139	Acoustic Fencing 56-59	Aran Panels 24-25	Anchor stakes 131	Automated Gates 108-111
B	Ballast 155	Balustrade 88-89	Balustrade Gates 89	Balustrade; Spur Posts 89	Barbed Tape 142	Barbed Wire 130
	Barbed Wire; High Tensile 130	Barbican Imperial® Railings 60-61	Barbican Imperial®; Finials 61	Barriers 138	Bollards; Timber & Metal 138-139	Bow Top Gates 62-63
	Bow Top Panels 62-63	Brabourne Gate 68	Bridle Gates 136	Brook Gate 68		
C	Canterbury Combi 36-37	Cut Width Kit 38-39	Canterbury Combi Gates 71	Canterbury Combi Panels 38-39	Cantilevered Gates 104-105	Capping Rails 54-55
	Cathedral Courtyard Gate 110-111	Cattle Fence 131	Cement 155	Chain Link 146-149	Chain Link Accessories 154	Chain Link Gates 150-151
	Chain Mesh 128	Chilham Gates 70	Chilham Panel Cut Down Kit 35	Chilham Panels 30-31	Cleft Chestnut Fencing 132-133	Closeboard Fencing 46-47
	Containing Boards 125	Corner Posts 48-49	Courtyard Gates 100-101			
D	Decking 86-90	Decking Boards 86-90	Decking Fixings 87	Decking; Anti-slip 86	Deer Fence 129	Diamond Rail Fencing 135
	Diamond Trellis Panels 79	Driveway Gates 110-113				
E	Edging Boards 125	Electric Gates 108-111	End Posts 48-49	End Grain Treatment 55	Entrance Gates; Narrow & Wide 112-114	Estate Gate 120-121
	Estate Railing Fencing 120-121	Estate Railings Gates 120-121	EuroGuard® Combi Panels 64-65	EuroGuard® Combi Posts 64-65	EuroGuard® Panels 64-65	EuroGuard® Posts 64-65
	Express® Temporary Fencing 144					
F	Featherboard Capping 54-55	Featherboard Gates 67	Featherboard Gravel Boards 52-5	Featherboard Pales 46-47	Featherboard Panels 8-9	Featherboard Posts 48-49
	Featherboard Rails 46-47	Feather Edge Fencing 8-9	Field Gates 112-115	Finials 55	Fixing Tools 155-158	Forest Fence 131
G	Garden Shelters 92-95	Garden Gates 66-72	Gate Automation 108-110	Gate Fittings & Accessories 116-117	Gate Latches 117	Gate Posts 117
	Gravel Boards 52-53	Gravel Boards; Hedgehog Friendly 53	The 25 Year Jakcure® Guarantee 4-5			
H	Hanging Posts 117	Heavy Duty Capping 55	Heavy Duty Posts 48-49	Heavy Metal Field Gates 118-119	Hit & Miss Cut Down Kit 16-17	Hit & Miss Panels 16-17
	Venetian Hit & Miss Panels 22-23	Vertical & Horizontal Hit & Miss Gates 67	Hythe Gates 100-101			
I	Intercoms 110	Intermediate Posts 48-49	J-lock 69	Jakclips 155	Jak-Deck Kits 90	Jakcure® Cut Treatment 55
	Jakcure® Guarantee 4-5	Jakousti® Barriers 56-58	Jakposts 48-49	Jaktop Gate Posts 51	Jaktop Gates 72	Jaktop Panels 40-41
	Jaktop Posts 48-49	Jakwall® Landscape Timbers 84-85	Jakwall® Fixings 85	Jumping Poles 125		
K	Kissing Gates both Timber 135	Kissing Gates both Metal 135	Knee Rail 137			
L	Landscape Timber 84-85	Lattice Panels 80	Lattice Wing Panels 80	Locks 69,117	Louvre Panels 18-19	
M	Marker Posts 141	Marker Rails 141	Metal Field Gate; Heavy 118-119	Metal Trellis 81	Metro Panels 30-31	Mi-T Metal Garden Fence Posts 50
	Mitre Panels 26-27					
N	Nails 156	Noise Barriers 56-59				
O	Ornamental Gates 106-108					
P	Paddock Fencing 122-127	Palisade Gate Posts 48-49	Palisade Gates; Rounded & Pointed tops 72	Palisade Pales; Pointed & Rounded 42-43	Palisade Panels 42-43	Palisade Posts 44-45
	Palisade Rails 44-45	Palisade; Level Top & Concave Panels 42-43	Pergola Components 76-77	Pergola; Corner 77	Pergolas; Single & Double Bay 76-77	Picket Fencing 44-45
	Pig Fence 131	Planters 98-99	Plain Wire 130	Playtime Timber Gates 62-63	Playtime Timber Panels 62-63	Post & Chain Fencing 137
	Post & Rail; Heavy 122-123	Post & Rail; Morticed 126-127	Post & Rail; Standard (Nailed) 124-125	Post Caps 55	Postcrete 155	Posts 48-49
	Preservative for Timber Treatment 55					
R	Railing Panel Courtyard Gate 100-101	Railing Topper Panels 12-13	Railings - Sentry Residential 60-61	Razor Wire 143	Retreat Garden Shelters 92-95	Reflectors 138
	Riding Arenas 124-125	Rota-Spike® 143	Rye Gates 100-101			
S	Screws 155	Security Comb 142	Security Topping 142-143	Sentry Residential Railings 60-61	Shadowline Panels 38-39	Sheep Fencing 131
	Shelters 92-95	Silver Rail Fencing 137	Sissinghurst Planters 98-99	Slam Posts 117	Slatted Fencing 18-23	Sleepers 84-85
	Sliding Gates 104-111					
T	Tartan Trellis Panels 82-83	Temporary Fencing 144	Tennis Court Fencing 153	Timber Treatment Process 4-5	Tongue & Groove Effect Panels (vertical & horizontal) 10-13	Tools 155-158
	Topper Panels Metal 14-15	Traditional Palisade or Picket Tree & Netting Stakes 131	Trellis Gate; Standard Square Top 72	Trellis Gates for Premier Trellis 72	Trellis Panels 78-83	Trellis Topper Panel; Convex 81
	Trellis Concave 81	Trellis Wing Panel 80	Trellis; Metal 81	Trellis; Standard Square Top 81	Tubular Steel Fencing 145-148	Tubular Steel Gates 150-151
U	Uni-Gates 114-115	Urban Fencing 36-37	Urban Gates 70			
V	Venetian Gates 70	Venetian Hit & Miss Gate Treatment 70	Venetian Hit & Miss Panels 22-23	Venetian Panel Cut Down Kit 21,23	Venetian Panels 20-21	Verge Protection 140-141
	Viper-Spike® 143					
W	Wall Plates 117	Warden Barrier 140	Welded Mesh; Heavy & Light 153	Wheelie Bin Store 96-97	Wire Netting 130	Wire Mesh 128
	Woven Gates 70	Woven Panel Cut Down Kit 34-35	Woven Panels 34-35	Woven Retreat Garden Shelter 94-95		



25 year Jakcure® Guarantee

Jakcure® treated timber is guaranteed for 25 years from the date of purchase and installation in line with our installation documents where available (see website for details) against failure, as a result of rot or insect attack which renders the timber unfit for its purpose. Any Jakcure® treated product, unless specifically excluded, so damaged within 25 years of purchase will be replaced free of charge.

To Qualify:

1. An online guarantee registration form must be completed for each Order Acknowledgment or Invoice Number.
2. Gravel boards must be used wherever the fence is in direct contact with the ground or likely to become so over time.
3. When timber is cross cut or drilled on site, it must be treated immediately with Jakcure® Cut Treatment.
4. Timber sections used in-ground should not be cut, drilled, notched or planed after factory Jakcure® treatment.
5. Any timber subject to a claim must be returned for inspection supported by evidence of the date of purchase e.g. original Order Acknowledgment or Invoice from Jacksons Fencing or Jacksons Approved Installer.
6. The guarantee is limited to the cost of the product. It does not cover any associated costs, including but not limited to, removal of the defective product, disposal of the defective product, installation of the replacement product and any associated labour costs.
7. Failure of the timber by any cause other than rot or insect attack is not covered.
8. Timber used in abnormal conditions is excluded, e.g next to rotten timber, buried in ground when not designed to be or prolonged exposure to salt water or other corrosive environments.
9. Timber used for other purpose than its designed usage is excluded. Note, the Jakcure® treated products designed for use in-ground are Posts (all variants), Gravel Boards, Containing Boards, Jakwall, Sleepers and Gate Stops.
10. The Jacksons 25-year Jakcure® Guarantee applies to purchases made in the UK on products for use within the UK only.

The Jacksons 25-year Jakcure® Guarantee is offered in addition to your statutory rights. See pages 4 - 5 for more details on the Jakcure® treatment process.

Metric / Imperial Conversion Chart*

mm	inch	m	ft & inches	*The conversions from Metric to Imperial measurements shown here are nominal.
25	1	0.9	2' 11½"	
32	1¼	1.05	3' 5½"	
38	1½	1.2	3' 11"	
50	2	1.5	4' 11"	
60	2¾	1.8	5' 10½"	
75	3	1.83	6'	
100	4	2.1	6' 10"	
125	5	2.4	7' 10"	
150	6	2.7	8' 10"	
175	7	3	9' 10"	
200	8	3.3	10' 9½"	
250	10	3.6	11' 9½"	
300	12	3.9	12' 9½"	
400	16	4.2	13' 9"	
500	20	4.6	15' 1"	
600	24			

Delivery Charge (per each drop)

We deliver to mainland - England and Wales south of (and not including) the counties of Cumbria, Durham and Cleveland. We do deliver further north but we quote to do so.

Delivery Area 1 - National (Excluding Area 2 and above.)

Delivery Area 2 - London, Cornwall, Devon, Wales (note some parts of North East Wales are covered by our local delivery charge)*

Delivery	Area 1	Area 2
For orders under £50.00 add	£31.50 +VAT	£41.50 +VAT
For orders under £150.00 add	£40.00 +VAT	£50.00 +VAT
For orders over £150.00 add	£52.00 +VAT	£62.00 +VAT

Local deliveries from our head office are charged at a reduced price. Enquire with our sales team for exact pricing relating to delivery.

Express delivery - 24 and 48 hours can be arranged at additional cost.

We shall be pleased to quote competitively for delivery to north of Lancashire/Yorkshire border, Scotland, Ireland, I.O.M., The Orkneys, The Shetlands and The Isle of Wight.

Please note our drivers are instructed not to take their lorries off the hard road.

*Please check our website for our full list of postcode areas.

Jacksons Fencing: Approved Installer Programme

Jacksons offers you a nationwide installation service that you can absolutely rely on. Our Approved Installers have all been carefully selected and are highly experienced professionals who will do the job competitively and without skimping - and get it right.

We have developed a Customer Charter for your reassurance of our joint commitment to quality. This Charter establishes the Code of Practice expected from a Jacksons Approved Installer and your expectations from them. A copy of your Charter will be presented to you with your quotation. Throughout the process from enquiry to completion of the installation, specific quality procedures must be adhered to by both Jacksons and the Jacksons Approved Installer. These cover all aspects of the installation in accordance with Jacksons instructions and best practices, working competently and responsibly throughout the duration of the contract.

Please call - 0800 41 43 43 with your initial enquiry and we will arrange for a Jacksons Approved Installer to contact you and give you a no obligation quotation.



Roll Lengths		Wire Gauges - Galv		Wire Gauges - PVC coated	
4.55m	15 ft/5 yds	● 1.6mm	16g	2.24/3.15mm	13½/10½g
6m	20 ft	● 2.0mm	14g	2.5/3.55mm	12½/9½g
9.1m	30 ft/10 yds	● 2.5mm	12½g	3.0/4.0mm	10½/8g
10m	32 ft	● 3.0mm	10½g	3.55/4.75mm	9½/6½g
12.5m	41 ft	● 3.15mm	10g		
25m	82 ft	● 3.5mm	9½g		
30m	98 ft	● 4.0mm	8g		
		● 5.0mm	6g		

If you have any difficulty in working out any dimensions in our brochure: Please do call 0800 41 43 43.

Where To Find Us And How To Contact

Jacksons Fencing have three Fencing Centres situated in the south east, the south west and the north west of the country. To find out which is the closest to you check out our location maps on these pages.

Head Office - South East:

Jacksons Fencing, Stowting Common, Ashford, Kent, TN25 6BN.
Tel: 01233 750393 | sales@jacksons-fencing.co.uk
www.jacksons-fencing.co.uk

Office Opening hours: Mon - Fri: 8:00 - 17:30
Jakstore Opening Hours: Mon - Fri: 7:30 - 17:30
Sat: 8:00 - 13:00 (winter)

Opening hours/days can be subject to change, please check the website for our latest times. To order a brochure or for other enquiries call: 01233 750393 during these hours.

South West:

Jacksons Fencing, New Rock, Chilcompton Bath, BA3 4GJ
Tel: 01761 232666 | sales-bath@jacksons-fencing.co.uk

Opening hours: Mon - Fri 8:00 - 17:30 and Sat please call to check

North West:

Jacksons Fencing, Dragon Hall, Whitchurch Road, Tattenhall, Chester, CH3 9DU
Tel: 01829 770776 | sales-chester@jacksons-fencing.co.uk

Opening hours: Mon - Fri 8.00 - 17:30 & Sat please call to check

French Enquiries: E-mail: france@jacksons-fencing.co.uk | www.jacksons-clotures.com

Isle of Wight Agent: County Fencing Supplies

Tel: +44 (0) 1983 741 207 | www.countyfencingsupplies.co.uk

Guernsey Agent:

R H Gaudion & Sons Ltd | Tel: 01481 257361
www.gaudioncampduroi.com

Jersey Agent:

JF(T)U Town and Country | Tel: 01534 733277 | www.jftu.co.uk

International:

Tel: +44 (0) 1233 750393 | export@jacksons-fencing.co.uk

Terms & Conditions: For a copy of our Consumer, Trade or Approved Installer Terms and Conditions please contact our Head Office.

Prices: Any prices quoted exclude VAT. **Consumer Terms:** Nett cash with order. **Trade Terms:** Nett 15th of the month following month of delivery for approved accounts. **Prices:** Due to unpredictable supplies and prices of raw materials we reserve the right to charge rates ruling at the time of delivery. **Sizes:** Orders may be delivered in imperial or metric dimensions, with tolerances to conform to BSS.

Catalogue Content: Errors and omissions excepted, the specifications contained in this catalogue were, to the best of our knowledge, accurate at the time of proofing and printing. We reserve the right to alter product specifications at any time in accordance with our policy of continuous improvement.

Call 0800 41 43 43 or log on to www.jacksons-fencing.co.uk

Jacksons Fencing and Jacksons Fine Fencing are registered names of H S Jackson & Son (Fencing) Ltd.



Opening hours/days can be subject to change, please check the web site for latest times www.jacksons-fencing.co.uk

Jacksons Fencing

CRAFTED FOR LIFE MADE WITH PASSION



DISCOVER PREMIUM QUALITY
FENCING, GATES AND ACCESSORIES
WITH A 25 YEAR GUARANTEE

WWW.JACKSONS-FENCING.CO.UK

ISSUE 5 - VOLUME 2

JF / MKT / GFG / 0422 / V5 NP

Jacksons Fencing - Head office: Stowting Common, Ashford, Kent, TN25 6BN
Phone: 01233 750393 | Fax: 01233 750403 | International: +44 (0) 1233 750393
Locations: Ashford, Bath and Chester
sales@jacksons-fencing.co.uk | www.jacksons-fencing.co.uk

Registered Office: Stowting Common, Ashford, Kent, TN25 6BN, United Kingdom. Registered in England No. 910291.