

Jacksons Fencing

Crafted For Life, Made With Passion.



The Good Fencing Guide Price Book

All prices exclude VAT

www.jacksons-fencing.co.uk

March 2019

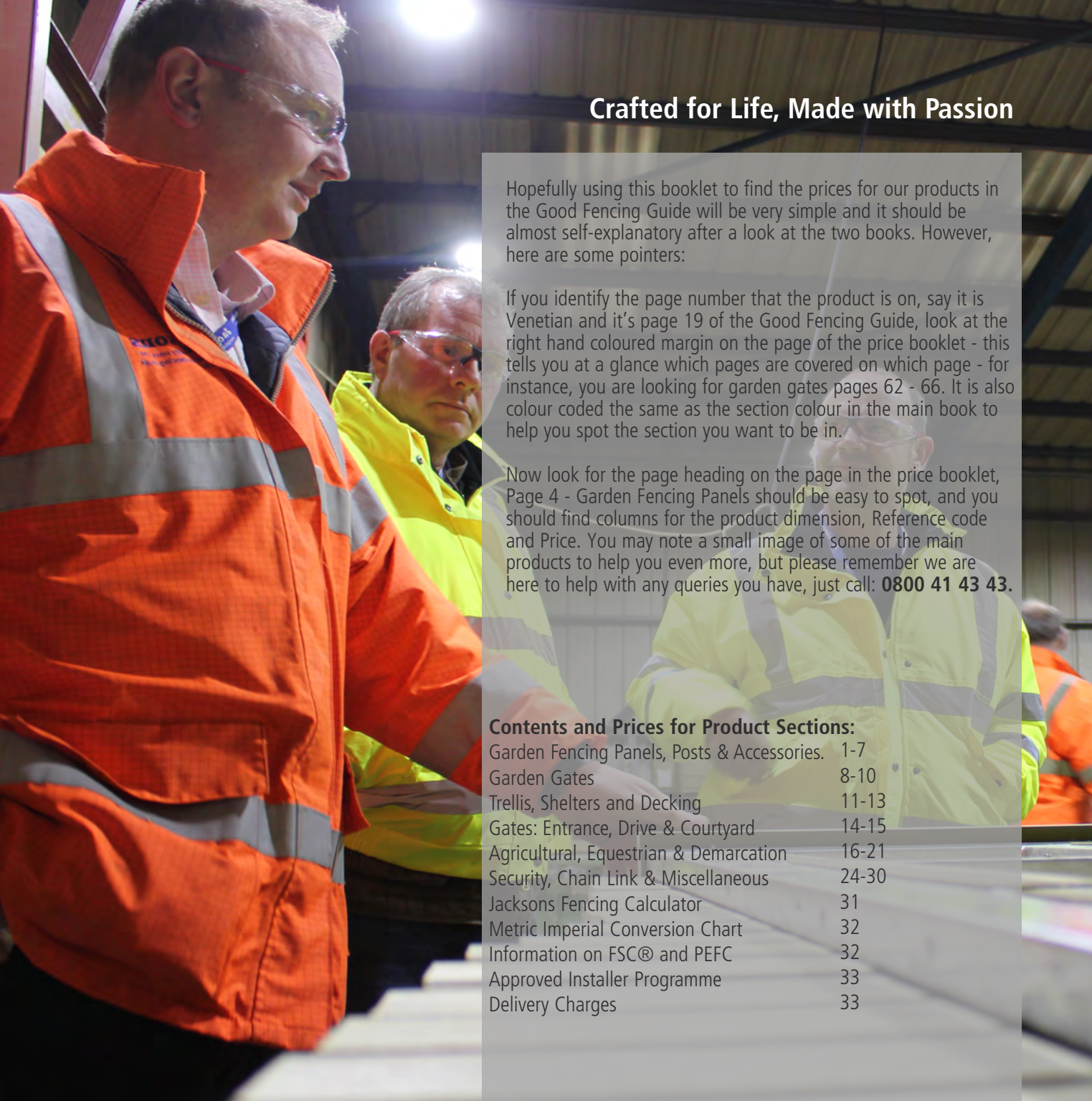

Crafted for Life, Made with Passion

Hopefully using this booklet to find the prices for our products in the Good Fencing Guide will be very simple and it should be almost self-explanatory after a look at the two books. However, here are some pointers:



If you identify the page number that the product is on, say it is Venetian and it's page 19 of the Good Fencing Guide, look at the right hand coloured margin on the page of the price booklet - this tells you at a glance which pages are covered on which page - for instance, you are looking for garden gates pages 62 - 66. It is also colour coded the same as the section colour in the main book to help you spot the section you want to be in.

Now look for the page heading on the page in the price booklet, Page 4 - Garden Fencing Panels should be easy to spot, and you should find columns for the product dimension, Reference code and Price. You may note a small image of some of the main products to help you even more, but please remember we are here to help with any queries you have, just call: **0800 41 43 43**.

Contents and Prices for Product Sections:

Garden Fencing Panels, Posts & Accessories.	1-7
Garden Gates	8-10
Trellis, Shelters and Decking	11-13
Gates: Entrance, Drive & Courtyard	14-15
Agricultural, Equestrian & Demarcation	16-21
Security, Chain Link & Miscellaneous	24-30
Jacksons Fencing Calculator	31
Metric Imperial Conversion Chart	32
Information on FSC® and PEFC	32
Approved Installer Programme	33
Delivery Charges	33

Featherboard Panels (page 9)

Level top	Height	Ref	Price	Concave	Height*	Ref	Price	Convex	Height*	Ref	Price
	0.6m	636900	■ £20.95		1.05m	635000	○ £34.60		1.05m (0.9m at sides)	635300	○ £34.60
	0.9m	637000	● £27.20		1.2m	636000	○ £37.70		1.2m (1.05m at sides)	636700	○ £37.70
	1.05m	636100	● £29.90		1.35m	635100	○ £40.90		1.35m (1.2m at sides)	635400	○ £40.90
	1.2m	637100	● £32.90		1.5m	636400	○ £43.80		1.5m (1.35m at sides)	636800	○ £43.80
	1.35m	636200	● £35.90		1.65m	635200	○ £47.20		1.65m (1.5m at sides)	635500	○ £47.20
	1.5m	637200	● £38.45						1.8m (1.65m at sides)	636500	● £49.90
	1.65m	636300	● £41.50								
	1.8m	637300	● £43.90								

*Height at highest point

*Height at highest point

Tongue & Groove Effect Vertical Panels (page 11)

Level top

Height	Ref	Price
0.91m	630100	● £53.20
1.22m	630200	● £66.45
1.52m	630300	● £80.75
1.65m	630000	● £86.65
1.83m	630400	● £92.15

Convex

Height*	Ref	Price
1.52m	630310	● £105.60
1.83m	630410	● £117.10

*Height at highest point

Panel cut width kits

For use if panel will need to be cut on site.
For Tongue and Groove Effect Panels.

Height	Ref	Price
0.91m	630100K	● £8.50
1.22m	630200K	● £8.50
1.52m	630300K	● £8.50
1.65m	630000K	● £8.50
1.83m	630400K	● £8.50

Capping for Panels Weathered Two Ways (page 50)

Ref	Price
1.83m x 65mm x 35mm 667777	● £3.95



Standard Capping for Panels (page 51)

Planed timber with 2 rounded edges

Ref	Price
1.88m x 120 x 25mm 667700	● £4.90
2.01m x 120 x 25mm 667772	● £4.90

(to be cut to suit ends & corners)



Jakcure® End Grain Treatment

Where cutting or drilling after treatment cannot be avoided use Jakcure® End Grain Treatment to ensure no timber is left untreated.

Ref	Price
500g bottle 131212	● £5.50



Railing Topper Panels (page 15)

Level top



Concave



Convex



Level Top	Ref	Price
	084101	■ £106.25
Concave	084201	■ £107.15
Convex	084301	■ £117.65



Aran Panels

Height Available	Ref	Price
1.83m	656618 ○	£82.15

Mitre Panels

Height Available	Ref	Price
1.0m	229010 ○	£36.25
1.2m	229012 ○	£42.00



p.25



p.27

Jakcure® End Grain Treatment

Where cutting or drilling after treatment cannot be avoided use Jakcure® End Grain Treatment to ensure no timber is left untreated.

500g bottle

Ref	Price
131212 ●	£5.50





Storm Panels

Height Available	Ref	Price
1.2m	658200 / 658312 ○	£80.40



p.29

Metro Panels

Height Available	Ref	Price
0.607m	657906 ○	£29.00
0.907m	657909 ○	£38.60
Gravel boards	667620 ○	£8.85



p.31

Posts for Metro fencing can vary in height depending on the chosen fence panel height combination ranging from 1.2m up to 3.0m. Please enquire with our sales team to confirm your exact requirements.

Tongue & Groove Effect Horizontal Panels (page 13)

Height	Ref	Price
0.91m	632009 ●	£53.20
1.22m	632012 ●	£66.45
1.52m	632015 ●	£80.75
1.65m	632016 ●	£86.65
1.83m	632018 ●	£92.15

Panel cut width kits

For use if panel will need to be cut on site. For Tongue and Groove Effect Panels.

Height	Ref	Price
0.91m	657100K ●	£8.50
1.22m	657200K ●	£8.50
1.52m	657300K ●	£8.50
1.65m	657350K ●	£8.50
1.83m	657400K ●	£8.50

Vertical and Horizontal Hit and Miss (page 17)
Vertical Hit & Miss

Height	Ref	Price
0.91m	634300 ●	£46.50
1.22m	634200 ●	£56.60
1.52m	634100 ●	£67.30
1.83m	634000 ●	£78.40

Horizontal Hit & Miss

Height	Ref	Price
0.91m	631500 ●	£46.50
1.22m	631600 ●	£56.60
1.52m	631700 ●	£67.30
1.83m	634000 ●	£78.40

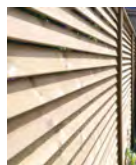
Louvre (page 19)

Height	Ref	Price
0.91m	658109 ○	£77.20
1.22m	658112 ○	£91.00
1.52m	658115 ■	£105.00
1.83m	658118 ●	£119.00

Venetian (page 21)

Height	Ref	Price
0.61m	657000 ●	£44.35
0.91m	657100 ●	£56.30
1.22m	657200 ●	£68.30
1.52m	657300 ●	£81.55
1.65m	657350 ●	£88.25
1.83m	657400 ●	£93.45

Venetian Hit & Miss (page 23)

Height	Ref	Price
0.6m	657806 ●	£56.50
0.9m	657809 ●	£72.50

Panel cut width kits

For use if panel will need to be cut on site. For Venetian Hit & Miss Panels

Height	Ref	Price
0.6m	657806K ●	£8.50
0.9m	657809K ●	£8.50
1.83m std	657800K ●	£8.50

Chilham (page 33)

Height	Ref	Price
0.91m	656000 ●	£67.35
1.22m	656100 ●	£80.80
1.52m	656200 ●	£95.90
1.83m	656300 ●	£109.70

For use if panel will need to be cut on site. For Chilham Panels

Height	Ref	Price
0.91m	656000K ●	£8.50
1.22m	656100K ●	£8.50
1.52m	656200K ●	£8.50
1.83m	656300K ●	£8.50

Canterbury Combi (page 37)

Height	Ref	Price
1.83m	658018 ●	£102.50

For use if panel will need to be cut on site. For Canterbury Combi Panels

Height	Ref	Price
1.83m std	658018K ●	£8.50

Woven (page 35)

Height	Ref	Price
0.91m	656700 ■	£48.90
1.22m	656800 ■	£59.90
1.52m	656500 ■	£81.20
1.83m	656600 ■	£92.70

Panel cut width kits

For use if panel will need to be cut on site. For Woven Panels

Height	Ref	Price
1.83m std	656600K ●	£8.50

Please Note: from February 2018 our Canterbury Combi panel has been modified to ensure a contemporary design. Should you require panels pre-February 2018 please do let us know.

Jakcure® End Grain Treatment

Where cutting or drilling after treatment cannot be avoided use Jakcure® End Grain Treatment to ensure no timber is left untreated. 500g bottle

Panel cut width kits

For use if panel will need to be cut on site. For Venetian Panels

Height	Ref	Price
0.61m	657000K ●	£8.50
0.91m	657100K ●	£8.50
1.22m	657200K ●	£8.50
1.52m	657300K ●	£8.50
1.65m	657350K ●	£8.50
1.83m	657400K ●	£8.50

Ref	Price
131212 ●	£5.50

Panel cut width kits

For use if panel will need to be cut on site. For Chilham Panels

All prices were correct at the time of printing, but due to fluctuating raw material costs we reserve the right to alter prices. The latest product prices can be found on our website

All prices exclude VAT

Buy Online: www.jacksons-fencing.co.uk or Call: 0800 41 43 43 for Sales or Advice

Jaktop Panels (page 39)



Jaktop Panels

(for use with slotted posts)

Height	Ref	Price
0.86m	600600 ■	£28.60
1.2m	600700 ■	£36.40

Palisade Panels (page 41)



Height	Ref	Price
Rounded tops		
1.0m	223500 ●	£28.30
1.2m	223600 ●	£32.70



Height	Ref	Price
Pointed tops		
1.0m	224500 ■	£27.60
1.2m	224600 ○	£31.90

Traditional Palisade Fencing (page 43)



Palisade Fencing Posts (for Traditional Fencing)

Height	Intermediate		Rounded tops		Pointed tops	
	Ref	Price	Ref	Price	Ref	Price
1.5m	223100 ●	£11.25	220100 ●	£11.25		
1.8m	224100 ●	£13.45	221300 ■	£13.45		
2.4m	225400 ●	£21.00	225500 ○	£21.00		



Palisade Fencing Rails (for Traditional Fencing)

Size	Ref	Price
2.4m long nominal 87 x 38mm section, scarfed both ends	221700 ●	£6.35

Palisade Fencing Pales (for Traditional Fencing)

Height	Rounded tops		Pointed tops	
	Ref	Price	Ref	Price
1m	223000 ●	£1.25	220400 ●	£1.25
1.2m	224000 ●	£1.50	221600 ●	£1.50
1.8m	225200 ●	£2.20	225300 ○	£2.20

Height	Price
1m	£19.04
1.2m	£21.63
1.8m	£32.53

Guide price per m for Traditional Palisade fencing

Palisade Fencing Corner Posts (for Traditional Fencing)

These are 0.6m longer than the fence height & are 100 x 100mm section. Planed & morticed two ways.

Fence Height	Post Height	Rounded tops		Pointed tops	
		Ref	Price	Ref	Price
1m	1.5m	223200 ●	£13.30	220800 ●	£13.30
1.2m	1.8m	224200 ●	£15.85	222000 ■	£15.85
1.8m	2.4m	225600 ■	£21.00	225700 ○	£21.00

Traditional Featherboard Fencing (page 44 - 45)

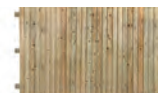

Featherboard Rails (for Traditional Fencing)

Size	Ref	Price
2.4m x 87 x 37mm	231400 ●	£6.40

Featherboard Pales (for Traditional Fencing) 29 per section

Fence Height	Pale Height	Ref	Price
with gravel board			
1.2m	1.05m	230400 ●	£0.86
1.5m	1.35m	230500 ●	£1.10
1.8m	1.65m	230600 ●	£1.35
without gravel board			
0.9m	0.9m	232300 ●	£0.73
1.2m	1.2m	232400 ●	£0.99
1.5m	1.5m	232500 ●	£1.23
1.8m	1.8m	232600 ●	£1.47

Guide price per m	Height	1.2m	1.5m	1.8m
Price		£28.29	£36.68	£41.10

Featherboard Posts (for Traditional Fencing)

125 x 100mm section recessed for rails 2 or 3 times according to height

Fence Height	Post Height	Ref	Price
1.2m	1.8m	230100 ●	£19.70
1.5m	2.4m	230200 ●	£26.25
1.8m	2.7m	230300 ●	£29.50

Featherboard Corner Posts (for Traditional Fencing)

125 x 125mm weathered two ways.

Fence Height	Post Height	Ref	Price
1.2m	1.8m	230800 ●	£25.20
1.5m	2.4m	230900 ■	£33.55
1.8m	2.7m	231000 ●	£37.70

Featherboard Gravel Boards (for Traditional Fencing)

Size	Ref	Price
2.4m x 150 x 25mm	230700 ●	£8.35

Capping for Traditional Featherboard fencing

2.4m kit with fixings	Ref 232200BM ●	Price £14.95
-----------------------	----------------	--------------

● STOCK ITEMS ○ MADE TO ORDER (CANNOT BE CANCELLED ONCE ORDERED) ■ CHECK FOR AVAILABILITY ▼ WHILE STOCK LASTS * INCLUDES BOLTS AND SCREWS

Slotted Jakpost and Standard Posts (page 46)

Slotted Jakposts

Posts are 100 x 100mm with two 54 x 25mm slots for panels.

Intermediate



Corner Posts



End Posts



Fence Height	Post Length	Ref	Price	Ref	Price	Ref	Price
0.6 & 0.75m	1.06m	756200 ●	£9.60	756300 ●	£9.60	756100 ●	£11.70
0.9m & 0.75m	1.5m	667200 ●	£13.40	667220 ●	£13.40	668200 ●	£16.35
1.05m & 1.2m	1.8m	667300 ●	£15.90	667330 ●	£15.90	668300 ●	£19.45
1.4m & 1.5m	2.1m	667400 ●	£18.40	667440 ●	£18.40	668400 ●	£22.50
1.65m & 1.85m	2.4m	667500 ●	£20.95	667550 ●	£20.95	668500 ●	£25.60
2.0m	2.7m	667800 ●	£23.40	667880 ●	£23.40	668800 ●	£28.65

Heavy Duty Jakposts

Posts are 120 x 124mm with two 54 x 25mm slots for panels.

Intermediate



Corner Posts



End Posts



Certain conditions i.e. strong winds call for stronger posts or for them to be dug deeper into the ground - if you have any queries please ask for advice	Post Length	Ref	Price	Ref	Price	Ref	Price
	2.7m	669000 ●	£35.40	669010 ●	£39.80	669011 ●	£41.25
	3.0m	669100 ●	£39.50	669110 ●	£43.80	669111 ●	£45.45
	3.3m	669200 ●	£42.70	669220 ●	£47.80	669222 ●	£49.60
	3.6m	669300 ●	£46.60	669330 ●	£52.20	669333 ●	£54.15
	3.9m	669400 ●	£49.80	669440 ●	£52.60	669444 ●	£58.75

Screws (page 47)

Stainless Steel Self-Drilling Countersunk Torx Head Screw Pack of 200 60mm

Ref 809900 ● Price £18.80

Stainless Steel Self-Drilling Countersunk Torx Head Screw Pack of 100 60mm

Ref 809911 ● Price £10.90

Hedgehog Gravel Boards (page 48)

1.83m long.	Ref	Price
For use with Slotted Posts	667610 ●	£12.25
Support Peg 600 x 50 x 50mm	644400 ●	£1.10

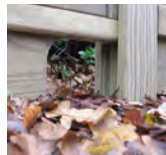

Gravel Boards (page 49)

1.83m long	Ref	Price
150 x 28mm with 22mm packers	667600 ●	£8.25
2.40m long		
150 x 25mm	230700 ●	£7.85



Post Caps and Finials (page 50)

Style - Size	Ref	Price
A: for use with 75 x 75mm posts	640900 ●	£0.75
B1: for use with 100 x 100mm posts	641000 ●	£1.10
B2: for use with 125 x 125mm posts	640660 ●	£1.90
C: for use with 100 x 100mm posts	668000 ●	£0.75
D: for use with 75 x 75mm posts	645400BM ●	£4.25
E: for use with 75 x 75mm posts	645600BM ●	£4.50
F: for use with 100 x 100mm posts	645700BM ●	£6.90
K: for use with 100 x 100mm posts	645880BM ●	£5.90



All prices were correct at the time of printing, but due to fluctuating raw material costs we reserve the right to alter prices. The latest product prices can be found on our website

All Prices Exclude VAT

Buy Online: www.jacksons-fencing.co.uk or Call: 0800 41 43 43 for Sales or Advice

Square Section Panel Posts (page 46)

Planed finish (not slotted). These are standard square section posts without the unique slot that our superior slotted Jakposts have.

Standard Panel Posts Size: 70 x 70mm nominal

Fence Height	Post Length	Ref	Price
0.6m	1.2m	640100 ■	£5.95
0.9m	1.5m	640200 ●	£7.45
1.2m	1.8m	640300 ●	£8.90
1.5m	2.1m	640400 ●	£10.40
1.8m	2.4m	640500 ●	£11.90
2.1m	2.7m	640600 ●	£13.30



Heavy Duty Panel Posts

Size: 91 x 91mm nominal Jakcured posts for hanging light gates etc.

Certain conditions i.e. strong winds call for stronger posts or for them to be dug deeper into the ground - if you have any queries please ask for advice	Post Length	Ref	Price
	1.2m	641100 ■	£10.35
	1.5m	641200 ●	£12.95
	1.8m	641300 ●	£15.50
	2.1m	641400 ●	£18.10
	2.4m	641500 ●	£20.70
	2.7m	641600 ●	£23.25
	3.0m	641700 ●	£25.85
	3.3m	641800 ●	£28.40
	3.6m	641900 ●	£31.00

Capping for Panels Weathered Two Ways (page 50)

	Ref	Price
1.83m x 65mm x 35mm	667777 ●	£3.95



Standard Capping for Panels (page 51)

Planed timber with 2 rounded edges

	Ref	Price
1.88m x 120 x 25mm	667700 ●	£4.90
2.01m x 120 x 25mm	667772 ●	£4.90

(to be cut to suit ends & corners)



Heavy Duty Capping Rail (page 51)

For intermediate slotted posts

	Ref	Price
1.900m x 145 x 35mm	667700H ■	£8.90

For end and corner slotted posts

	Ref	Price
1.985m x 145 x 35mm	667770H ■	£8.90

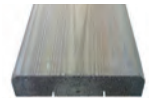

Jakoustic Acoustic Barriers (page 52 - 55)

Priced by quotation, please ask.

Barbican Imperial Residential Railings (page 56 - 57)



Railings Galv. & PPC

Height	Ref	Price
1.00m	979100 ○	£136.55
1.25m	979120 ○	£152.55

Intermediate Posts

	Ref	Price
1.00m	971001 ○	£24.20
1.25m	971251 ○	£27.40

Corner Posts

	Ref	Price
1.00m	971003 ○	£25.90
1.25m	971253 ○	£29.05

End Posts

	Ref	Price
1.00m	971002 ○	£24.20
1.25m	971252 ○	£27.40

Finials

	Ref	Price
Finial 1	957010	£65.70
Finial 2	957020	£52.25
Finial 3	957030	£54.10
Finial 4	957040	£48.40
Finial 5	957050	£67.60
Finial 6	957060	£52.25



Sentry Residential Railings (page 56)

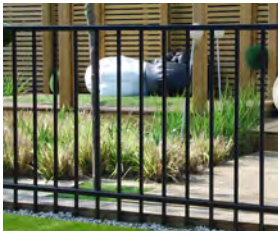

Railings Galv. & PPC

Height	Ref	Price
1.00m	921000 ○	£148.50
1.25m	921200 ○	£166.90

Intermediate Posts

	Ref	Price
1.00m	921001 ○	£24.20
1.25m	921201 ○	£27.40

Corner Posts

	Ref	Price
1.00m	921002 ○	£25.90
1.25m	921202 ○	£29.05

End Posts

	Ref	Price
1.00m	921001 ○	£24.20
1.25m	921201 ○	£27.40

Connectors

	Ref	Price
	020001 ○	£1.20



Bow Top panels and Gates (page 59) (Timber Playtime Panels - Price on Application)

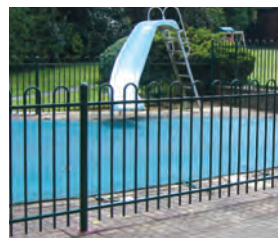

Bow Top Panels

Panel Height	Ref	Price
1m high	071460 ○	P.O.A
1.2m high	071462 ○	P.O.A

Posts for panels		Ref	Price
1m high		071402 ○	P.O.A
1.2m high		071403 ○	P.O.A

Connector (4 /panel)	Ref	Price
	020000 ○	P.O.A

Bow Top Gates

Height	Ref	Price
Single gate 0.9m wide		
1m high	071440BM ○	P.O.A
1.2m high	071450BM ○	P.O.A
Double gates 3m wide		
1m high	071406 ○	P.O.A
1.2m high	071407 ○	P.O.A

Bow Top is galvanised as standard, please ask about coating prices.

Playtime Timber Fencing & Gates (page 59)

Priced by quotation, please ask.

EuroGuard® Regular Panels (page 61)



EuroGuard® Panels

Galvanised as standard, please ask about coating prices.

Height	Width	Ref	Price
1.50m	3.00m	073156 ○	P.O.A
1.80m	3.00m	073157 ○	P.O.A
2.00m	3.00m	073158 ○	P.O.A

EuroGuard® Posts

Height	Fence height	Ref	Price
2.1m	1.5m	073067 ○	P.O.A
2.5m	1.8m	073068 ○	P.O.A
2.8m	2.0m	073069 ○	P.O.A
Clips for fixing (3 per post)		073163BM ○	P.O.A
Driving tool for screws		073160 ○	£29.95

P.O.A - Price On Application

EuroGuard® Combi (page 61)

EuroGuard® Combi (3.0m wide)

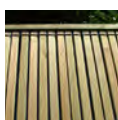

Panels (inc panels & slats)

Height	Ref	Price
1.58m	747200S ■	P.O.A
2.00m	747250S ■	P.O.A

Posts (inc posts, covers & 6 connects)

Height	Ref	Price
2.0m	748020S ■	P.O.A
2.5m	748025S ■	P.O.A

Fixing Tool

Ref 073160 Price £29.95

P.O.A - Price on application

Featherboard Gates (page 62)

Featherboard Gates (Level Top)

Gate Height	Gate Width	Ref	Price
1.18m	1.00m	231100 ●	£128.00
1.48m	1.00m	231200 ●	£138.00
1.78m	900mm	231900 ●	£150.00
1.78m	1.00m	231300 ●	£152.00
1.93m	1.00m	232000 ●	£161.00



Brook Gate (page 63)

Gate Height	Gate Width	Ref	Price
1.18m	1.00m	275800 ○	£158.00
1.48m	1.00m	275900 ○	£171.00
1.78m	750mm	276000 ●	£168.00
1.78m	900mm	276100 ●	£177.00
1.78m	1.00m	276200 ●	£184.00
1.93m	1.00m	276250 ●	£198.00



Concave Featherboard Gates

Gate Height	Gate Width	Ref	Price
1.15m	1.00m	231101 ○	£136.00
1.45m	1.00m	231211 ○	£149.00
1.75m	1.00m	231301 ○	£161.00



Brabourne Gate (page 63) (Convex Top)

Gate Height	Gate Width	Ref	Price
1.15m	1.00m	277100 ○	£161.00
1.45m	1.00m	277200 ○	£172.00
1.75m	750mm	277300 ●	£176.00
1.75m	900mm	277400 ●	£184.00
1.75m	1.00m	277500 ●	£190.00



Convex Featherboard Gates

Gate Height	Gate Width	Ref	Price
1.15m	1.00m	231102 ○	£136.00
1.45m	1.00m	231202 ○	£149.00
1.75m	1.00m	231302 ○	£161.00



All prices were correct at the time of printing, but due to fluctuating raw material costs we reserve the right to alter prices. The latest product prices can be found on our website

All Prices Exclude VAT

Buy Online: www.jacksons-fencing.co.uk or Call: 0800 41 43 43 for Sales or Advice

J-Lock and Latch (page 64)

	Ref	Price
J-Lock fitted	357700BM ○	£165.00
J-Lock supply only	357770BM ■	£112.00



Wall Plates (page 63)

	Ref	Price
1.8m Planed Finish 95 x 70mm	228000 ●	£12.65
2.1m Planed Finish 95 x 70mm	228050 ■	£14.60
2.4m Planed Finish 95 x 70mm	228100 ■	£16.60
1.8m Planed Finish 95 x 45mm	171000 ●	£8.60



Hit and Miss Gates Vertical (page 64)

Gate Height	Gate Width	Ref	Price
1.78m Right handed	1.00m	631900 ●	£146.00
1.78m Left handed	1.00m	631990 ●	£146.00



Hit and Miss Gates Horizontal (page 64)

Gate Height	Gate Width	Ref	Price
1.78m Right handed	1.00m	631800 ●	£146.00
1.78m Left handed	1.00m	631880 ●	£146.00



Chilham Gates (page 65)

Gate Height	Gate Width	Ref	Price
1.78m Right handed	1.00m	656400 ●	£164.00
1.78m Left handed	1.00m	656440 ●	£164.00



Venetian Gates (page 65)

Gate Height	Gate Width	Ref	Price
1.78m Right handed	1.00m	657700 ●	£158.00
1.78m Left handed	1.00m	657770 ●	£158.00



Canterbury Combi Gates (page 65)

Gate Height	Gate Width	Ref	Price
1.78m Right handed	1.00m	659000 ●	£180.00
1.78m Left handed	1.00m	659090 ●	£180.00



Woven Gates (page 65)

Gate Height	Gate Width	Ref	Price
1.78m Right handed	1.00m	656610 ○	£172.00
1.78m Left handed	1.00m	656611 ○	£172.00



Jakcure® End Grain Treatment

Where cutting or drilling after treatment cannot be avoided use Jakcure® End Grain Treatment to ensure no timber is left untreated.

	Ref	Price
500g bottle	131212 ●	£5.50



Mitre Gates (page 25)

Gate Height	Gate Width	Ref	Price
0.95m Right handed	1.00m	229100 ○	£94.00
0.95m Left handed	1.00m	229110 ○	£94.00
1.15m Right handed	1.00m	229200 ○	£99.00
1.15m Left handed	1.00m	229220 ○	£99.00



Square Top Standard Trellis Gates (page 66)

Gate Height	Gate Width	Ref	Price
1.78m Right handed	1.00m	639500 ○	£114.00
1.78m Left handed	1.00m	639550 ○	£114.00



Premier Trellis Gates (page 66)

Gate Height	Gate Width	Ref	Price
1.78m 100mm Square	1.00m	740000 ○	£157.00
Lattice	1.00m	750000 ○	£172.00
Diamond	1.00m	744000 ○	£164.00

Jaktop Gates (page 66)

Gate Height	Gate Width	Ref	Price
0.86m	1.00m	602600 ○	£104.00
1.15m	1.00m	602900 ○	£112.00
0.86m	1.20m	602700 ○	£108.00
1.15m	1.20m	603000 ○	£117.00
0.86m	1.50m	602800 ○	£117.00
1.15m	1.50m	603100 ○	£133.00



Palisade Gates Rounded Pale tops (page 66)

Gate Height	Gate Width	Ref	Price
0.95m	1.00m	223300 ●	£87.60
1.15m	1.00m	224300 ●	£92.30
1.75m	1.00m	225800 ○	£108.30



Palisade Gates Pointed Pale tops (page 66)

Gate Height	Gate Width	Ref	Price
0.95m	1.00m	222700 ●	£87.60
1.15m	1.00m	222600 ●	£92.30
1.75m	1.00m	225900 ○	£108.30



Centre Gate Stop

602200 ■ £8.55

Palisade Gate Posts (page 66)

1.5m & 1.8m are 100 x 75mm & 2.4m are 125 x 75mm section (not morticed).

Gate Height	Post Height	Rounded Tops Ref	Price	Pointed Tops Ref	Price
0.95m	1.5m	223400 ●	£12.15	220500 ●	£12.15
1.17m	1.8m	224400 ●	£14.50	220600 ■	£14.50
1.75m	2.4m	226800 ■	£22.60	226500 ○	£22.60

Pergola Systems (page 71)

Pergola Item	Ref	Price
A: Short Cross Member 0.57m	650100 ■	£2.55
B1: Long Cross Member 1.8m	650200 ■	£9.15
B2: Long Cross Member 2.1m	650800 ■	£10.20
B3: Long Cross Member 2.4m	650900 ■	£11.25
B4: Long Cross Member 2.7m	651000 ■	£12.25
D: Spacer Block	650700 ■	£0.40
F: In Line Brace 0.5m	650400 ■	£4.40
G: Corner Brace 590mm	650500 ■	£2.10
H: Post 91 x 91mm	641600 ●	£23.25
J: Post Top	650750 ■	£1.10
K: Mid Side Rail 1.92m	650300 ■	£7.05
L: End side Rail 2.174m	650310 ■	£7.95
M: Double End Side Rail 2.42m	650320 ■	£8.95

Pergola Price Calculator

Single Pergola	Price	Price	Price	Price
Width	1 Bay	2 Bays	3 Bays	Extra Bays
1.8m	£196.60	£323.15	£450.10	£130.55
2.10m	£200.80	£330.50	£460.60	£133.70
2.40m	£205.00	£337.85	£471.10	£136.85
2.70m	£209.00	£344.85	£481.10	£139.85
Fixings pack	£8.25	£8.25	£8.25	£8.25

Corner Pergola (page 69)

Price (3x panels)	£465.00
656900BM ○	
Price (2x panels)	£332.00
656990BM ○	



Pergola Pack

Ref	Price
PERGOLA	£8.25

All prices were correct at the time of printing, but due to fluctuating raw material costs we reserve the right to alter prices. The latest product prices can be found on our website.

The Premier Trellis Range (page 74)

Trellis Panels

Panel framing is 45 x 51mm with 25 x 12mm battens. (100mm squares)



Height	Width	Ref	Price
300mm	1830mm	740100 ●	£26.25
430mm	1830mm	740200 ○	£31.45
560mm	1830mm	740300 ●	£36.70
810mm	1830mm	740500 ○	£46.95
940mm	1830mm	740600 ○	£52.25
1190mm	1830mm	740800 ○	£62.50
1320mm	1830mm	740900 ○	£67.75
1450mm	1830mm	741000 ○	£72.95
1570mm	1830mm	741100 ○	£78.00
1830mm	1830mm	741300 ●	£88.50

Lattice Panels

Panel framing is 45 x 51mm with 25 x 12mm battens. (38mm squares)



Height	Width	Ref	Price
300mm	1830mm	750100 ●	£34.80
430mm	1830mm	750200 ○	£43.10
560mm	1830mm	750300 ○	£51.35
810mm	1830mm	750500 ○	£67.60
940mm	1830mm	750600 ○	£75.95
1190mm	1830mm	750800 ○	£92.25
1320mm	1830mm	750900 ○	£99.90
1450mm	1830mm	751000 ○	£108.75
1570mm	1830mm	751100 ○	£116.75
1830mm	1830mm	751300 ●	£133.00

Diamond Trellis Panels

Panel framing is 45 x 51mm with 25 x 12mm battens. (100mm squares)



Height	Width	Ref	Price
300mm	1830mm	742500 ○	£28.20
430mm	1830mm	742600 ○	£33.85
560mm	1830mm	742700 ○	£39.45
940mm	1830mm	743000 ○	£56.15
1190mm	1830mm	743100 ○	£67.20
1450mm	1830mm	743300 ○	£78.45
1830mm	1830mm	743700 ●	£95.15

Panel width cut down kits are available for all Premier trellis and Tartan trellis panels, please ask or see the website.

Premier Lattice Wing Panel

560 x 940mm (38mm squares)

Item	Ref	Price
Pair	775000BM ○	£74.00
Left handed single panel	775010 ○	£37.00
Right handed single panel	775020 ○	£37.00



Premier Trellis Wing Panel

560 x 940mm (100mm squares)

Item	Ref	Price
Pair	744000BM ○	£52.00
Left handed single panel	744010 ○	£26.00
Right handed single panel	744020 ○	£26.00



Premier Concave Topper Panel

(100mm squares)

Size	Ref	Price
1830 x 560mm at ends	742200 ○	£42.50



Premier Convex Topper Panel

430mm at the ends (100mm squares)

Size	Ref	Price
1830 x 560mm at centre	742100 ○	£42.50



Standard Trellis Range (page 75)

Standard Square Topper Panels

Size	Ref	Price
0.3m high	638700 ●	£15.80
0.6m high	638100 ●	£21.45



Standard Square Trellis

Panel Height	Holes	Ref	Price
0.86m	5	638200 ■	£27.00
1.18m	7	638300 ■	£32.65
1.50m	9	638400 ■	£38.30
1.83m	11	638500 ■	£44.28



Metal Trellis (page 69)

Size	Ref	Price
2m x 700mm	957070 ■	£36.90
Fixings (6 req)	816000B ■	£1.95



Tartan Trellis (page 77)

Height	Ref	Price
1.83m	752300 ○	£116.50



Panel width cut down kits are available for all Premier Trellis and Tartan Trellis panels (741300K), please ask or see the website.

Curved Framed Trellis

1.83m wide x 300mm high diamond trellis

Ref 745300 ■ Price £59.50



Jakwall Grooved & Ungrooved (page 79)



Size	Ref	Price
2.35m x 140mm x 90mm grooved on 90mm face	171700 ○	£30.90
2.35m x 140mm x 90mm grooved on 140mm one face only	171801 ●	£30.90
2.35m x 140mm x 90mm grooved all round	171900 ○	£33.50
2.35m x 140mm x 90mm not grooved	171910 ●	£29.50

Decking Boards and Fittings (page 80)

Decking sizes	Ref	Price
Heavy decking board 3.0m x 150 x 32mm (nominal)	755901 ■	£9.95
Heavy decking board 3.6m x 150 x 32mm (nominal)	755900 ■	£11.95
Heavy decking board 4.2m x 150 x 32mm (nominal)	755902 ■	£13.95
Heavy decking board 4.8m x 150 x 32mm (nominal)	755910 ●	£15.95
Standard decking board 3.6m x 100 x 25mm (nominal)	755600 ●	£6.85
Standard decking board 4.2m x 100 x 25mm (nominal)	755610 ■	£7.95
Fittings		
Decking joist 3.0m x 100mm x 50mm	755100 ●	£11.15
Decking joist 3.6m x 100mm x 50mm	755200 ●	£13.35
Decking joist 3.6m x 150mm x 50mm	755220 ●	£19.95
Decking support post 0.6m x 100mm diameter	755300 ■	£4.30
Decking support post 0.9m x 100mm diameter	755400 ●	£5.85
Decking support post 1.2m x 100mm diameter	755500 ■	£7.45
60mm stainless steel screw T25 torx drive - 200	809902 ●	£19.95
60mm stainless steel screw T25 torx drive - 500	809905 ●	£49.90
Stainless steel self drilling screws 60 x 5mm / box 200	809900 ●	£18.80
2 tread decking stringer (850mm long)	759200 ■	£12.50
3 tread decking stringer (1200mm long)	759300 ■	£17.55
4 tread decking stringer (1530mm long)	759400 ■	£22.20
5 tread decking stringer (1865mm long)	759500 ■	£27.40
Weed Control Roll 12m roll x 1m wide	755777 ●	£13.95
Weed Control Sheeting 50m roll x 1m wide	755770 ●	£32.20

Posts, Galvanised Shoes, and Base Boards (page 83)

Item	Ref	Price
1060mm intermediate Jakpost	756200 ●	£9.60
1060mm corner Jakpost	756300 ●	£9.60
1060mm end Jakpost	756100 ●	£11.70
Post for Pergola Topping		
2100mm Intermediate post	667400 ■	£18.40
2100mm corner post	667440 ■	£18.40
2100mm end post	668400 ■	£22.50
PPC shoe & base plate for Inter (+ screws)	756000 ●	£10.60
PPC shoe & base plate for end/corner (+ screws)	756010 ●	£11.30
3.9m 120 x 21mm capping & base board	756800 ●	£10.50
1.5m long decking spur & packer	756310 ■	£15.25

Jakwall Fixings

Ref	Price
171710 ●	£0.63
171810 ●	£0.74
171720 ●	£7.60
171709 ●	£0.25

Landscape Sleepers (page 79)

2.4m long 200 x 100mm	171500 ■	£37.75
-----------------------	----------	--------

Slip Resistant Decking (page 82)

3.6m board	755900SR ■	£26.50
------------	------------	--------

Balustrade (page 82 - 83)

Style 1 Balustrade (Pales)

	Ref	Price
1.1m high panel	757300 ■	£48.00
1.82m wide panel		
Post infill piece		
2.0m x 50mm x 25mm	756350 ●	£3.20
Capping rail		
2.4m x 60mm	756810 ■	£8.20
3.9m x 120mm	756800 ●	£12.95



Style 1

Style 2 Balustrade (Spindles)

	Ref	Price
1.1m high		
Width		
1.83m	758300 ■	£64.20



Style 2

Balustrade Gates

	Ref	Price
1.0m wide		
Style 1		
Right handed	757900 ○	£110.00
Left handed	757990 ○	£110.00
Style 2		
Right handed	758900 ○	£120.00
Left handed	758990 ○	£120.00

Spur Post	Price
Ref 756310 ■	£15.25



All prices were correct at the time of printing, but due to fluctuating raw material costs we reserve the right to alter prices. The latest product prices can be found on our website.

All Prices Exclude VAT

Buy Online: www.jacksons-fencing.co.uk or Call: 0800 41 43 43 for Sales or Advice

Jak-Deck Kits (page 84)

Size	Ref	Price
1.8 x 1.8m	755001BM ■	£176.00
1.8 x 3.6m	755000BM ■	£306.00
3.6 x 3.6m	755002BM ■	£544.00



Venetian Retreat Garden Shelter (page 87)

	Ref	Price
Retreat Shelter	655700BM ○	£735.00
Retreat Shelter with polycarbonate roof covering	655710BM ○	£915.00
Gutter Kit for rear of optional roof sheet (Inc. gutter & down pipe)	673007BM ○	£83.00
Additional side panel (to fill right hand side)	655700C1 ○	£80.00
20kg Bag Postcrete	648070 ●	£4.95



Woven Retreat Garden Shelter (page 89)

	Ref	Price
Woven Retreat Shelter	655705BM ○	£735.00
Woven Retreat with polycarbonate roof covering	655715BM ○	£915.00
Gutter Kit for rear of optional roof sheet (Inc. gutter & downpipe)	673007BM ○	£83.00
Additional side panel (to fill right hand side)	656500 ○	£80.00
20kg Bag Postcrete	648070 ●	£4.95



Wheelie Bin Store (page 91)

	Ref	Price
Wheelie Bin Store (Double)	660710 ■	£245.00
Additional unit bin store (Left hanging door)	660711 ○	£125.00
Single slatted shelf (optional)	660712 ○	£19.00
Cabin hook (300mm) galvanised	351666 ■	£4.75



Sissinghurst Planters (page 93)

	Ref	Price
Square 560 x 560 x 500mm	753200 ■	£95.00
Long 1010 x 560 x 500mm	753201 ■	£136.00



● STOCK ITEMS ○ MADE TO ORDER (CANNOT BE CANCELLED ONCE ORDERED) ■ CHECK FOR AVAILABILITY ▼ WHILE STOCK LASTS * INCLUDES BOLTS AND SCREWS



We're proud of the quality of our products, here's one of the biggest reasons why...

Not a lot of people realise it, but even though Jacksons is one of the biggest fencing companies in the UK, people are amazed to find that our fencing and gates are hand made. Of course there are parts of the production process that are automated and machinery takes care of some of the cutting and drilling, but it's the hands on approach that makes the difference.

The Jacksons staff know that what they do is a hugely important part of the process. They are trained to assemble panels and gates with great care, checking every component that passes through their hands, as they run an experienced eye over the timber, noticing blemishes or knots. Anything that doesn't pass our strict quality control procedures and guidelines is taken out to be re-purposed. Nothing goes to waste, and it's this attention to detail and constant watchfulness over quality that is a key part of what makes a Jacksons fence, a great fence.

Courtyard Gates (pages 94 - 95)

Standard Courtyard Gates

We have a stock of our most popular sizes of the Hythe and the Rye gate below, for any other style or size please ask for a quotation, with no obligation.



A1 & A2



B1 & B2

Gate Height, width and style	Ref	Price
A1 1.8m high x 3.1m clear opening Rye Courtyard Gate	278770BM ●	£1170.00
A2 1.8m high x 3.6m clear opening Rye Courtyard Gate	278660BM ●	£1320.00
B1 1.8m high x 3.1m clear opening Hythe Courtyard Gate	278110BM ●	£1450.00
B2 1.8m high x 3.6m clear opening Hythe Courtyard Gate	278090BM ●	£1555.00
Galvanised post for 1.8m high Rye Courtyard Gate	079093R ●	£236.70
Galvanised post for 1.8m high Hythe Courtyard Gate	079093 ●	£236.70
Extra over for timber clad posts	CY/CLAD	£200.00
Mortice lock and lockable drop bolt bracket option	357400BM ■	£110.00
Stop post	351900BM ■	£16.75

Railing Panel & Cathedral style (page 97)
 Courtyard Gates Priced by quotation, please ask.
 Timber Sliding Gates Priced by quotation, please ask. (page 99)
 Hardwood Gates Priced by quotation, please ask. (page 101)
 Ornamental Gates Priced by quotation, please ask. (page 103)
 Residential Gate Operators Priced by quotation, please ask. (p. 105)
 Access Control Options Priced by quotation, please ask. (pages 106 - 107)

All prices were correct at the time of printing, but due to fluctuating raw material costs we reserve the right to alter prices. The latest product prices can be found on our website.

All Prices Exclude VAT

Buy Online: www.jacksons-fencing.co.uk or Call: 0800 41 43 43 for Sales or Advice

Entrance Gates for the Drive or Field (page 109)

Entrance Gate

Gate height 1.2m high, except for the curved hanging stile that is 1.5m high



Entrance Gate Narrow

Length	Ref	Price
0.9m	262800 ■	£117.50
1.2m	262900 ■	£127.75
1.5m	263000 ○	£139.00

Entrance Gate Wide

Length	Ref	Price
1.8m	263100 ○	£165.65
2.1m	263200 ○	£179.30
2.4m	263300 ○	£193.70
2.7m	263400 ○	£208.00
3.0m	263500 ■	£219.50
3.3m	263600 ○	£234.70
3.6m	263700 ■	£245.00

Uni-Gates (page 111)

Uni-Gate

Gates are 1.27m high overall



Narrow Uni-Gates

Length	Ref	Price
0.9m*	255000 ●	£53.30
1.05m*	255090 ●	£59.70
1.2m	251100 ●	£69.95
1.5m	255200 ●	£78.85
1.8m	255300 ●	£87.65
2.1m	255400 ●	£96.40

*with a single brace

For gates under 2.1m please use the above code but add an 'R' for a right handed hanging gate option

Wide Uni-Gates

Length	Ref	Price
2.4m	255500 ●	£111.80
2.7m	256600 ●	£120.55
3.0m	257700 ●	£129.25
3.3m	258800 ●	£138.55
3.6m	259900 ●	£147.25
3.9m	256000 ●	£156.00
4.2m	256100 ●	£164.85

Fitting Packs for Uni and Entrance Gates

Items required for hanging a single narrow gate; Galvanised fittings, Hinge set, Spring catch fitted, anti-lift device, padlock & two 2.1m, 150 x 150mm gate posts.

Ref TRHSSLN ● Price £152.00

Items required to hang single gate; Galvanised fittings, Hinge set, Spring catch fitted, anti-lift device, padlock, 2.1m, 175 x 175mm Hanging post & 2.1m, 150 x 150mm Shutting post

Ref TRHSSL ● Price £167.10

Items required for hanging double leaf wide gate (includes loop over, drop bolt & centre gate stop etc.)

Ref TRHSDL ● Price £256.75

Additional Fitting Packs/Hanging Systems for Uni and Entrance gates

For double leaf gates hung behind posts, inc Hinges, Loopover, CGS, Fitting of irons - NO POSTS

Ref TRHSDLNP ● Price £140.95

For single leaf gate hung behind posts, inc Posts, Hinges, Auto catch, Fitting of irons

Ref TRHSSLAC ● Price £164.95

For single leaf gate hung between posts, inc Posts, Hinges, Spring catch, Fitting of irons

Ref TRHSSLBP ● Price £167.10

For narrow leaf Uni or Entrance gate hung behind posts, inc Posts, Hinges, Auto catch, Fitting of irons

Ref TRHSSLNAC ● Price £149.85

For narrow leaf gate hung between posts, inc Hinges, Spring catch, Fitting of irons

Ref TRHSSLNBP ● Price £152.00

For single leaf gate hung behind posts, inc Hinges, Spring catch, Fitting of irons - NO POSTS

Ref TRHSSLNP ● Price £66.40

For single leaf gate hung behind posts, inc Hinges, Auto catch, Fitting of irons - NO POSTS

Ref TRHSSLNPAC ● Price £64.25

For single leaf gate hung between posts, inc Hinges, Spring catch, Fitting of irons - NO POSTS

Ref TRHSSLNPBP ● Price £66.40

Automation - All gates featured on this page can be automated with adjustment please call: 0800 41 43 43 for a quotation.

STOCK ITEMS ○ MADE TO ORDER (CANNOT BE CANCELLED ONCE ORDERED) ■ CHECK FOR AVAILABILITY ▼ WHILE STOCK LASTS * INCLUDES BOLTS AND SCREWS

Galvanised Fittings and Gate Accessories (pages 112 - 113)

Item	Ref	Price	Item	Ref	Price
Spring Catch Set	271300 ●	£14.50	Universal Hold Back Catch for wood or metal gates with wear plates	272000 ●	£22.25
Spring Catch Set alternative item	271350BM ●	£14.50			
Hinge Set with adjustable bottom hinge for wooden posts supplied with anti-theft nuts	271800 ●	£21.95	Loopover Catch complete with bolt (for connecting two gates) and staple with extra knob	271410 ●	£15.95
Hinge Set with hooks to build into brickwork	274100 ●	£43.55	Auto Catch with striker	438300 ●	£12.35
Hinge Set with double swing rockerbottom hinge for wooden posts	350100 ●	£94.00	Drop Bolt	351400 ●	£9.35
Pair Hooks on 100mm plate 19mm pin	438400 ●	£11.25	Heavy Lockable Drop Bolt	351410BM	£14.70
Pair of Hinge Hooks for concrete or wooden posts from 150 - 250mm (extra long)	438500 ●	£18.85	Anti-Lift device for padlock (Not for use with hooks on plates Ref 4384)	271200BM	£19.95
Wrought Heavy Latch for gates with rocker bottom hinge	351010BM ●	£24.65	Fitting irons to gates	271700 ●	£10.00
Gate Catch to fix in cement with wear plates	1BSLPOST ●	£21.25	Gate Latch-GRP General Purpose - 1 way lockable	354600	£26.20
Gate Catch with wooden stump and wear plates 1.8m x 100 x 100mm to support full height of gate and catch on 2nd rail down for use on Entrance and Uni- Field gates	351800BM ▼	£38.35	Gate Latch Deluxe 2 Way lockable - rust free, lock from either side of the gate	354700	£41.45
Self closing adjustable hinge for timber gate	354400 ●	£48.80			
Self closing adjustable hinge for steel gate	354420 ●	£31.00			

Safety Warning: Jacksons magnetic pull latches are designed to be operated by adults only. Children must be supervised at all times if operating moving parts.

The Vertical Pull Latch is ideal for gates that need to always be closed, for example swimming pool gates and where you need to confine pets, only to be operated by an adult.



Ref 354330 ● Price £44.95

The Extended Pull Latch is the same as the Vertical Pull Latch, but the handle has been extended to ensure toddlers cannot reach the latch.



Ref 354500 ● Price £46.70

The Pull Latch is a general all purpose latch suitable for gates that do not require the security of a keyed lock.



Ref 354200 ● Price £19.40

Gate Posts and Gate latches (page 114)

Hanging Posts for Field Gates

Length	Section	Ref	Price
2.1m Fine sawn finish	175 x 175mm	272400 ●	£57.90
2.1m Fine sawn finish	150 x 150mm	274000 ●	£42.80



Slam Posts

Length	Section	Ref	Price
2.1m Fine sawn finish	150 x 150mm	274000 ●	£42.80

Gate Posts for Special Gates

Length	Section	Ref	Price
2.4m Fine sawn finish	125 x 125mm	272500 ●	£34.20
2.4m Fine sawn finish	175 x 175mm	273800 ●	£66.20
2.4m Fine sawn finish	150 x 150mm	273900 ●	£48.80
2.7m Fine sawn finish	125 x 125mm	272600 ●	£38.35
2.7m Fine sawn finish	150 x 150mm	274090 ●	£54.75
2.7m Fine sawn finish	175 x 175mm	273880 ●	£80.50



Wall Plates

Length	Section	Ref	Price
1.8m Planed finish	95 x 70mm	228000 ●	£12.65
2.1m Planed finish	95 x 70mm	228050 ■	£14.60
2.4m Planed finish	95 x 70mm	228100 ■	£16.60
1.8m Planed finish	95 x 45mm	171000 ●	£8.60
2.1m Planed finish	95 x 45mm	171021 ●	£9.85
2.4m Planed finish	95 x 45mm	171024 ●	£11.15



Centre Gate Stops

450 x 115 x 150mm	Ref	Price
For use with entrance and uni-gates	927110 ■	£11.85
Courtyard gates 65mm	927120 ●	£14.60
Featherboard and boarded gates	602200 ■	£9.35



All prices were correct at the time of printing, but due to fluctuating raw material costs we reserve the right to alter prices. The latest product prices can be found on our website.

All Prices Exclude VAT

Buy Online: www.jacksons-fencing.co.uk or Call: 0800 41 43 43 for Sales or Advice

Heavy Metal Field Gates (page 115)

Standard un-clad			Clad with welded mesh		
Length	Ref	Price	Length	Ref	Price
1.2m	440800 ○	£102.95	1.2m	440880BM ○	£122.40
2.1m	441100 ○	£126.45	2.1m	441110BM ○	£165.15
2.4m	441200 ○	£134.95	2.4m	441220BM ○	£173.70
2.7m	441300 ○	£143.95	2.7m	441330BM ○	£202.10
3.0m	440200 ●	£147.50	3.0m	440220BM ○	£205.60
3.3m	440300 ●	£155.55	3.3m	440330BM ○	£213.65
3.6m	440400 ●	£163.75	3.6m	440440BM ○	£221.85
4.2m	440500 ●	£180.25	4.2m	440550BM ○	£257.75
4.6m	440600 ●	£199.75	4.6m	440660BM ○	£277.25

Drop bolts and Loop over catches

Item	Ref	Price
Drop bolt	453880 ●	£29.15
Loop over catch	453700 ●	£26.55

Hanging Posts

Size	Ref	Price
1.875mm long 89mm Diam.	453200 ●	£52.65
1.875mm long 114mm Diam.	453100 ●	£67.20

Slam Posts

Item	Ref	Price
1.9m long	453600 ●	£44.30
88.9mm Diam.		

Special Heavy Post & Rail and Standard (nailed) Post & Rail (page 119)

Special Heavy Post and Rail Fencing



Posts			
Length	Mortices	Ref	Price

Corner Posts			
Length	Mortices	Ref	Price

Rails	Length	Ref	Price

Guide Price
3 rail per m £13.83 4 rail per m £18.06

Standard Post and Rail Fencing (nailed) (page 121)



Machine rounded, half-round Posts			
Length		Ref	Price
1.8m 115mm face		130400 ●	£7.35
1.8m 125mm face		150110 ●	£9.20
2.4m 125mm face		131300 ●	£12.10

Corner Posts			
Machine Rounded		Ref	Price
1.8m		130550 ●	£14.85
2.4m		130600 ○	£18.95

Machine rounded, half-round Rails			
Item		Ref	Price
3.6m 100mm face		135000 ●	£9.85

Example: 180m comprises: 180m with 100mm machine rounded rails & 1.8m posts.
3-rail (100 posts + 1 for the end of each run +150 rails). Guide price per m £12.57

Post and Rail Fencing (nailed)



Posts			
Length		Ref	Price
1.8m		170100 ●	£12.60
2.1m		170500 ●	£14.70

Square Rails			
Length		Ref	Price
3.6m long		170200 ●	£10.20

Half Round Rails			
Length		Ref	Price
3.6m long with 100mm face		135000 ●	£9.85

Example: 180m comprises: Three rail: 100 posts + 1 for the end of each run. 150 rails.
Guide price with sawn rails £15.81 or price with 100mm machine rounded £15.52

Post and Rail (morticed) and Post and Rail (nailed)

Post and Rail Fencing (morticed)



Posts			
Length	Mortices	Ref	Price
1.8m	3 Mortices	190200 ●	£15.95
2.1m	4 Mortices	190700 ○	£18.75

Corner Posts			
Length	Mortices	Ref	Price
1.8m	3 Mortices	190600 ●	£26.25
2.1m	4 Mortices	190800 ○	£30.55

Square Rails		
Length	Ref	Price
3.0m	190300 ●	£10.55

Prick Posts			
Length	Ref	Price	
1.5m long	190400 ●	£5.25	
1.8m long	190900 ○	£6.30	

Guide Price
3 rail per m - £18.79 4 rail per m - £23.85



Containing Boards

Size	Ref	Price
3.6m - 150 x 38mm	170400 ●	£15.30
4.0m - 150 x 38mm	170410 ●	£16.95

Splash Boards

Size	Ref	Price
3.6m - 150 x 25mm	170800 ●	£10.80

Chain Mesh Fencing (page 124)



Posts

Half round softwood, machine rounded and pointed 125mm across the face.

Length	Ref	Price
1.8m	150110 ●	£9.20

Square Rails Sawn Finish

Size	Ref	Price
100 x 38mm section. 4m long	170210 ●	£11.35

Jumping Poles

Size	Ref	Price
3.6m long x 100mm diameter	131800 ●	£17.80

Half Round Rails

Half round, machine rounded 100mm across face.

Corner Posts

Two sawn flat sides from round posts of 125mm diameter.

Length	Ref	Price
1.8m	130550 ●	£14.85

Length	Ref	Price
3.6m	135000 ●	£9.85

Chain Mesh

50mm mesh. Line wire is supplied with each roll. Supplied in 25m rolls, height 0.9m, 2.5mm gauge. Ref 300100 ● Price £78.90

Example: 200m comprises: 112 posts, 56 rails, 8 rolls chain mesh, 3kgs. Staples, 4kgs. 100mm Nails, 1 box of galvanised ring clips Guide price per m £11.17

Fencing Stakes and Posts (page 125)



Stakes

Softwood mixed cleft & round 75 - 100mm across or through the butts, peeled, pointed.

Length	Ref	Price
--------	-----	-------

Anchor Stakes

Half round with min of 75mm face, peeled.

Size	Ref	Price
------	-----	-------

Machine Rounded Fencing Stakes

Pointed, with chamfered tops.

75mm dia.	Ref	Price
1.5m long	091800 ●	£2.85
1.65m long	091900 ●	£3.15
1.8m long	092000 ●	£3.40
90mm dia.		
1.65m long	093200 ●	£4.75
1.8m long	093300 ●	£5.15

Straining and Corner Posts

Round and peeled.

Size	Ref	Price
Machine rounded		
Size	Ref	Price
2.1m long x dia. 150mm	093050 ■	£24.40
2.4m long x dia. 150mm	093055 ■	£28.80

Struts

Machine rounded. Min diameter of 60mm.

Size	Ref	Price
1.8m	114900 ●	£3.10

Wire Netting Galvanised to BS EN 10223 (page 126)

Mesh	Wire Gauge	600		900		1050		1200		1800	
		Ref	Price	Ref	Price	Ref	Price	Ref	Price	Ref	Price
50 Metre Rolls	25mm			193100 ●	£76.25			193300 ●	£101.40	193400 ●	£158.70
	31mm	193900 ●	£40.25			194100 ●	£78.25	194200 ●	£80.95		
					£44.30	194600 ■	£109.85	194700 ■	£145.00		
	50mm	195700 ●	£40.25	195900 ●				196000 ●	£68.55	196200 ●	£80.60

All prices were correct at the time of printing, but due to fluctuating raw material costs we reserve the right to alter prices. The latest product prices can be found on our website.



All prices exclude VAT

Buy Online: www.jacksons-fencing.co.uk or Call: 0800 41 43 43 for Sales or Advice

Barbed Wire (page 126)

Double strand, 200m with barbs at 100mm centres

Length	Gauge	Ref	Price
200m	2.5mm	321600 ●	£43.20
200m	1.6mm		
High tensile		321660 ●	£27.20



Plain Wire Mild steel galvanised (page 126)

Size	Approx Length	Ref	Price
25kg coils			
5.00mm(6g.)	162m	321000 □	£62.95
4.00mm(8g.)	254m	321100 ●	£47.80
3.15mm(10g.)	410m	321200 ●	£47.80
2.5mm(12g.)	651m	321300 ●	£47.80
2.0mm(14g.)	1017m	321400 ●	£47.80
1.6mm(16g.)	1590m	321700 □	£65.85
High Tensile			
3.15mm(10g.)	410m	321500 ●	£49.90
2.5mm(12½g.)	651m	321550 ●	£49.90

Actual size



Size	Approx Length	Ref	Price
5kg coils			
3.15mm (10g.)	82m	323100 ●	£10.90
2.50mm (12g.)	130m	323200 ●	£10.90
2.00mm (14g.)	203m	323300 ●	£10.90

Cattle or Stock Fence 1.15m (Double Life Galvan coated) (page 127)

Available in medium weight. Eight line wires and uprights 300mm apart.

Type	Ref	Gauge - Top & Bottom	Gauge Intermediate	Price
C8/11/30	320200 ●	3.0mm	2.5mm (50m rolls)	£74.25

Pig Fence 800mm (Double Life Galvan coated) (page 127)

Eight line wires and uprights 150mm apart

Type	Ref	Gauge - Top & Bottom	Gauge Intermediate	Price
Medium C8/80/15	320400 ●	3.0mm	2.5mm (50m rolls)	£56.90
High Tensile HT8/80/15	320440 ●	All wires 2.5mm (100m rolls)		£122.20

Sheep Fence 900mm (Double Life Galvan coated) (page 127)

Six line wires and uprights 300mm apart.

Type	Ref	Gauge - Top & Bottom	Gauge Intermediate	Price
Heavy B6/90/30	320700 ●	4.0mm	3mm (50m rolls)	£78.90
Medium C6/90/30	320800 ●	3.0mm	2.5mm (50m rolls)	£48.90

Tree and Netting Stakes (page 128)

Buckle Tree Ties

Size	Ref	Price
450mm	100900 ●	£0.70

60mm Diameter

Pointed and chamfered

Length	Ref	Price
1.5m	113500 ○	£2.75
1.8m	114400 ●	£3.30
2.1m	115200 ■	£3.85
2.4m	114500 ●	£4.35

75mm Diameter

Pointed and chamfered

Length	Ref	Price
2.1m	092100 ●	£5.25
2.4m	092200 ●	£5.95
2.7m	092300 ●	£7.35

Forest Fence 1.0m (Double Life Galvan coated) (page 127)

Seven line wires, uprights 150mm apart.

Type	Ref	Gauge - Top & Bottom	Gauge Intermediate	Price
Medium C7/10/15	325500 ●	3.0mm	2.5mm (50m rolls)	£73.40

Deer Fence 1.9m (page 127)

High Tensile (100m rolls). Vertical wires 150mm apart for perimeter fencing.

Type	Ref	Gauge - Top & Bottom	Gauge Intermediate	Price
High Tensile 13/190/15 (close uprights)	325600 ●	2.5mm	2.5mm	£266.00

Gripples (page 127)

Gripper Wire Tensioning Tool

Ref 326900 ● Price £68.70

Gripper for Mild steel barbed wire.

Ref 326880 ● Price £1.35

Gripple Wire Joiner

Ideal for joining both Mild & High Tensile steel wire 1.6mm-3.2mm & High Tensile barbed wire.

Ref 326800 ● Price £0.84

● STOCK ITEMS ○ MADE TO ORDER (CANNOT BE CANCELLED ONCE ORDERED) ■ CHECK FOR AVAILABILITY ▼ WHILE STOCK LASTS * INCLUDES BOLTS AND SCREWS □ SUPPLIED TO ORDER (CANNOT BE CANCELLED ONCE ORDERED) We reserve the right to alter specification in accordance with our policy of continuous improvement.

Cleft Chestnut Fencing (page 129)

Please note: Cleft Chestnut Fencing is not Jakcured timber.

Fence

Height	Ref	Price
Style 'A' 9.1m rolls		
0.9m	291000 ●	£47.90
1.1m	291600 ●	£55.40
Style 'B' 9.1m rolls		
0.9m	294000 ■	£51.65
1.1m	294600 ●	£60.85
Style 'B' 4.55m rolls		
1.2m	295500 ●	£36.65
1.4m	295800 ●	£42.00
1.5m	296400 ●	£45.90
1.8m	297000 ■	£52.25

Intermediate Posts

Machine round 75mm diameter use at 2.7m intervals

Fence Height	Post Length	Ref	Price
0.9m	1.5m	091800 ●	£2.85
1.1m	1.5m	091800 ●	£2.85
1.2m	1.65m	091900 ●	£3.15
1.4m	1.8m	092000 ●	£3.40
1.5m	2.1m	092100 ●	£5.25
1.8m	2.4m	092200 ●	£5.95

Anchor Stakes

Half round with minimum of 75mm face, pointed and peeled. One per strut 750 - 900mm

Ref 090900 ■ Price £1.30

Corner and End Posts

Machine rounded 100mm diam. Use at max 45m intervals or corners & changes in direction.

Fence Height	Post Length	Ref	Price
0.9m & 1.1m	1.5m	132100 ●	£7.65
1.2m & 1.4m	1.8m	132200 ●	£9.15
1.5m	2.1m	132220 ●	£10.65
1.8m	2.4m	132300 ●	£12.15

Struts

Machine rounded 60mm diam. Use one on end posts & two on corner & intermediate straining posts.

Fence Height	Post Length	Ref	Price
0.9m & 1.1m	1.4m	114700 ■	£2.35
1.2m & 1.4m	1.8m	114900 ●	£3.10
1.5m	2.1m	115000 ■	£3.65
1.8m	2.4m	115100 ■	£4.15

Kissing Gates (pages 130 - 131)

Standard timber Kissing Gate	Ref	Price
A Complete set	299900BM ■	£238.37
Mobility timber Kissing Gate	Ref	Price
B Complete set	299800BM ■	£304.53
Jacksons Galvanised Metal Kissing Gate		
Metal Kissing Gate	Ref	Price
Complete set	264600BM ○	£368.00
Sag Hook	Ref	Price
	271600 ●	£10.00

Padlock

Item	Ref	Price
RADAR padlock and three keys	284550BM	£64.80



A



B



Stiles and Bridle Gates (page 132)

Stile

Item	Ref	Price
Stile complete with dog gate	201700BM ○	£136.00
Stile (without dog gate)	200700BM ○	£94.00
Dog gate for attaching to existing stile	201800BM ○	£47.00

Bridle Gates

1 x 1.8m wide Universal Gate, 1.3m high overall
 2 x 2.1m hanging posts 150 x 150mm
 finish 1 x Hinge set with adjustable bottom
 hinge 1 x Spring catch set galvanised fitting
 irons to gate. When ordering please state either
 right or left hand hanging.

Ref 299770BM ■ Price £201.90

Two Way R.O.W. Latch

Two way latch especially suitable for self closing gates for disabled access. Supplied complete with latch timber packer and activating pin.

Ref 271100 ■ Price £29.80

All prices were correct at the time of printing, but due to fluctuating raw material costs we reserve the right to alter prices. The latest product prices can be found on our website.

All Prices Exclude VAT

Buy Online: www.jacksons-fencing.co.uk or Call: 0800 41 43 43 for Sales or Advice

Demarcation Devices and Landscape Timbers (page 133)



Diamond Rail Fencing

Posts	Ref	Price
0.9m long	200900 ■	£8.15
1.2m long	201000 ■	£10.75

Rails	Ref	Price
75 x 75mm nominal section 2.7m (posts at 1.35m centres)	640600 ●	£13.30
75 x 75mm nominal section 1.8m (posts at 1.8m centres)	640300 ●	£8.90
Galvanised Strap for Diamond Rail	201100 ●	£1.60

Post and Chain Fencing



Posts for Chain Fencing Jakcured Softwood 100mm square section, planed shaped top 1.5m **Ref 350900 ■** Price £14.55

Chain galvanised 50mm x 6mm links spikes in every other link price per metre **Ref 350600 ●** Price £8.90

Hooks galvanised for attaching chain to wooden posts (including screws) **Ref 350700 ●** Price £2.30

Silver Rail Fencing



	Ref	Price
Intermediate Post 1.5m	201200 ■	£12.50
Corner Post 1.5m	201300 ○	£22.25
End Post 1.5m	201500 ■	£12.80
Rails 6m Galvanised rail (41.5mm diam. inc. connector)	064000BM	£36.50

Timber Poles & Bollards (page 134)

Bollard	0.9m		1.2m		1.5m		1.8m		2.1m		2.4m		3.0m		3.6m		6.0m	
	Ref	Price	Ref	Price	Ref	Price	Ref	Price	Ref	Price	Ref	Price	Ref	Price	Ref	Price		
A 75mm	131400 ○	£2.70	131500 ○	£3.55														
100mm	131900 ●	£4.90	132000 ●	£7.45	132100 ●	£7.65	132200 ●	£9.15	132220 ●	£10.65	132300 ●	£12.20						
125mm	132400 ○	£7.35	132500 ○	£9.70	132600 ○	£11.95	132700 ○	£14.50			132800 ○	£19.25	132430 ●	£24.45	132436 ●	£29.30		
150mm	132900 ○	£10.55	133000 ○	£13.95	133100 ○	£17.40	133200 ○	£20.85			133300 ○	£27.70	132930 ●	£35.20	132936 ●	£42.20	132960 ●	£73.55
200mm																	134400 ●	£130.75
B 150mm	133900 ○	£10.95	134000 ○	£14.35	134100 ○	£17.80												
C 140mm	270100 ■	£19.55	270200 ■	£25.35														
150mm									274000 ●	£42.80	273900 ●	£48.80						
175mm									272400 ●	£57.90	273800 ●	£66.20						
D 140mm		£21.00	270220 ○	£26.80														
150mm		274200 ○	£22.50															
175mm		274600 ○	£29.85															



A



B



C



D

A. Machine rounded & chamfered

B. Machine rounded & grooved

C. Square with shaped top

(All sawn except 140mm)

D. Square with shaped top & grooved

(All sawn except 140mm)

Reflectors

Complete with fixings

Colour	Ref	Price
Amber	360100 ●	£1.55
White	360200 ●	£1.55
Red	360300 ●	£1.55





Metal Bollards (page 135)

	Ref	Price
Bollard		
1.4m x 101mm dia type 'K' domed top	138880 ○	£98.70
1.4m x 101mm dia type 'L' sloped top	138890 ○	£76.50

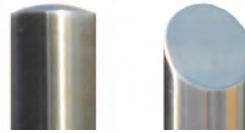

Base plated posts are available at an extra cost. Metal bollards are supplied galvanised as standard. Powder coating is extra, please ask for details

Metal Bollards

		1.5m	Ref	Price
E Domed top	178 x 5mm		136400 ○	£95.85
F Pyramidal top	100 x 100 x 3mm		137400 ○	£43.45
H Gold Dome top	178 x 5mm		138600 ○	£107.65
J Silver Dome top	178 x 5mm		138800 ○	£102.65

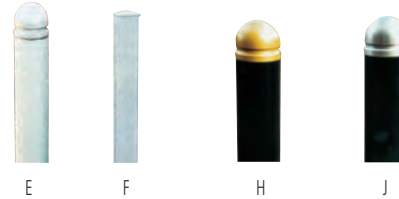

Page 136 - Verge Protection Marker Posts, Car and Lorry Stops and Barriers



Verge Protection Marker post
Posts come complete with either amber, red or white reflectors. Installed height 600mm.

	Post with either:	Ref	Price
	Amber reflector	200880BM ●	£17.50
	Red reflector	200882BM ●	£17.50
	White reflector	200888BM ●	£17.50

Reflectors

Complete with fixings		
Colour	Ref	Price
Amber	360100 ●	£1.55
White	360200 ●	£1.55
Red	360300 ●	£1.55



Security Rail (or fixed hoop barrier)

Ref 581300 ● Price £65.25



The Warden 3-9m (18m double) prices from £445.00

	Ref	Price
Single barrier up to 4.4m	581600 ○	
Barriers 4.5 - 6m	581601 ○	
Barriers 6.1 - 8m	581602 ○	



Danger Signs

Ref 329330 ● Price £3.30



High Tensile Barbed Wire	Length	Ref	Price
Best Jacksons galvanised barbed wire. Twin strand made to B.S.S.	200m 1.6mm	321660 ●	£27.20

Security Comb

Sizes: Supplied in 1.8m lengths. The double row of spikes is 40mm wide and depth of spikes 25mm. Fixing: Security Comb comes drilled ready for fixing.



1.8m lengths	Ref	Price
Galvanised Security Comb	010800 ●	£10.85
Galv. & coated Security Comb	910800 ○	£15.85

Cobra-Spike Standard

Spikes 110mm long. Pitch of spikes 80mm. Depth of spikes 95mm.



Cobra-Spike Standard	Ref	Price
Galvanised	010982 ●	£24.95
Galv. and coated	010990 ●	£29.95

All prices were correct at the time of printing, but due to fluctuating raw material costs we reserve the right to alter prices. The latest product prices can be found on our website.

Security Extras: Rota-Spike® and Viper-Spike® (page 138)

Rota-Spike® Security Toppings

Rota-Spikes sold in 6m lengths
(shorter lengths available) comprising:

	Ref	Price
6m galvanised rail	064000BM ●	£36.50
Rota-Spikes® for 6m	010994 ●	£168.75
End wall bracket	019991 ●	£9.30
Intermediate bracket	010998 ●	£7.35
Mitre corner	019992 ●	£2.65

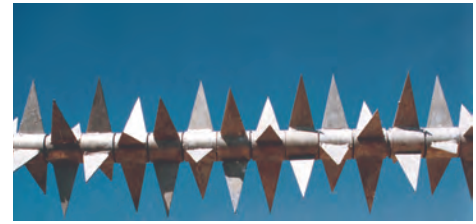

Viper-Spike® Security Toppings

Item	Ref	Price
Viper 1 (1.1m lengths)	010989 ●	£39.90
Viper 3	010993 ●	£43.00

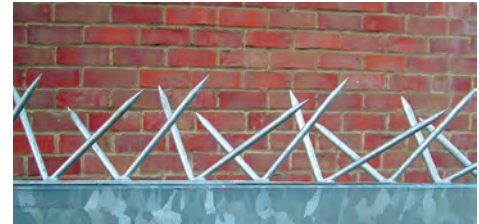

Security Extras: Barbed Tape (page 139)

Razor Wire Concertina Specification

	450mm	730mm	980mm
Coil diameter	450mm	730mm	980mm
Approx. coil length	8m	10-12m	10-15m
Extended diameter	400mm	620mm	820mm
Spirals turns per coil	54/55	54/55	54/55
Clips per spiral	3	5	5
Ref	327500 ●	327600 ●	327700 ●
Price	£32.55	£49.65	£60.50

Flat Wrap Barbed Tape

Coil Height	Approx. Coil Length	Ref	Price
500mm	12m	329000 ●	£61.25
700mm	14m	329100 ◻	£69.65
900mm	14m	329200 ◻	£80.60

Rolls of Barbed Tape

Medium, 200m
Ref 328300 ● Price £83.15

Express® Temporary Fencing (page 140)

Temporary Fencing	Ref	Price
Anti-Climb Heavy Duty	050010 ●	£33.40
Anti-Climb Standard	050008 ●	£29.95
Pedestrian gate 2m high x 1m wide	050200 ●	£56.55
1m high crowd control barrier	050009 ◻	£32.50
Accessories	Ref	Price
Fence coupler - 2 per panel std	050035 ●	£0.70
Gate Hinge	050036 ●	£7.95
Anti-Lift Device	050037 ●	£1.75
Barbed Wire Extension	050038 ●	£3.75

Please note: Express Temporary Fencing is not covered by the 25 Year Service Life

Footings	Ref	Price
Concrete Foot	050151 ●	£5.90
Thermoplastic foot*	050166 ●	£7.90
Double Metal Foot	050171 ◻	£5.85
Fence Stabiliser	050039 ●	£7.20



*Thermoplastic foot replaces previous plastic foot filled with concrete

Galvanised Tubular Fencing System (pages 142 - 143)

System 1 Medium

Intermediate posts

Fence Height	Ref	GALV	PPC
0.9m	061509BM	£11.50	£13.40
1.2m	061512BM	£14.00	£16.20
1.4m	061514BM	£15.15	£17.65
1.8m	061518BM	£17.95	£21.20

System 1 Heavy

Intermediate posts

End posts

Corner - 2 way posts

Fence Height	Ref	GALV	PPC	Ref	GALV	PPC	Ref	GALV	PPC
0.9m	061609BM	£15.35	£18.15	062609BM	£36.35	£43.60	063609BM	£58.15	£69.85
1.2m	061612BM	£18.60	£21.85	062612BM	£43.75	£53.35	063612BM	£70.55	£86.55
1.4m	061614BM	£20.25	£24.05	062614BM	£47.10	£57.75	063614BM	£75.60	£93.10
1.8m	061618BM	£24.35	£29.05	062618BM	£59.95	£72.60	063618BM	£93.00	£113.65
2.0m	061620BM	£26.80	£31.85	062620BM	£64.60	£78.10	063620BM	£99.40	£121.35
2.4m	061624BM	£34.05	£39.85	062624BM	£74.35	£90.15	063624BM	£115.00	£140.40
2.75m	061627BM	£40.30	£46.70	062627BM	£83.20	£99.10	063627BM	£129.25	£155.00
3.05m	061630BM	£59.00	£65.85	062630BM	£104.10	£122.65	063630BM	£152.55	£182.80
3.6m	061636BM	£66.65	£83.00	062636BM	£117.30	£146.00	063636BM	£170.60	£211.65

System 2

Intermediate posts

End posts

Corner - 2 way posts

Fence Height	Ref	GALV	PPC	Ref	GALV	PPC	Ref	GALV	PPC
1.8m	061718BM	£36.70	£42.35	062718BM	£72.90	£88.80	063718BM	£113.00	£139.15
2.0m	061720BM	£38.65	£44.65	062720BM	£76.55	£93.60	063720BM	£118.40	£145.90
2.4m	061724BM	£43.60	£50.25	062724BM	£86.35	£105.30	063724BM	£134.00	£164.60
2.75m	061727BM	£47.65	£54.90	062727BM	£95.15	£114.15	063727BM	£148.20	£184.30
3.05m	061730BM	£68.40	£84.00	062730BM	£118.10	£147.65	063730BM	£173.55	£217.10
3.6m	061736BM	£76.05	£93.60	062736BM	£131.30	£163.60	063736BM	£191.65	£238.60

System 3

Intermediate posts

End posts

Corner - 2 way posts

Fence Height	Ref	GALV	PPC	Ref	GALV	PPC	Ref	GALV	PPC
0.9m	061109BM	£16.60	£19.95	062109BM	£27.65	£32.80	063109BM	£40.75	£48.30
1.2m	061112BM	£19.85	£23.65	062112BM	£36.45	£43.60	063112BM	£52.85	£63.90
1.4m	061114BM	£21.50	£25.90	062114BM	£39.00	£47.00	063114BM	£55.95	£68.15
1.8m	061118BM	£25.60	£30.85	062118BM	£45.05	£54.30	063118BM	£63.25	£77.05
2.0m	061120BM	£28.05	£33.70	062120BM	£48.60	£58.40	063120BM	£67.35	£81.90
2.4m	061124BM	£35.35	£41.75	062124BM	£56.10	£67.70	063124BM	£78.45	£98.15
2.75m	061127BM	£41.55	£48.50	062127BM	£105.85	£137.05	063127BM	£174.50	£230.50
3.05m	061130BM	£59.60	£67.05	062130BM	£125.00	£158.55	063130BM	£194.40	£254.65
3.6m	061136BM	£67.90	£84.85	062136BM	£135.15	£178.40	063136BM	£206.30	£276.45

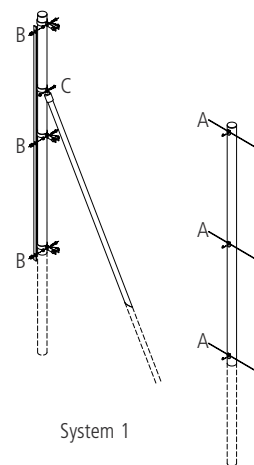

System 1

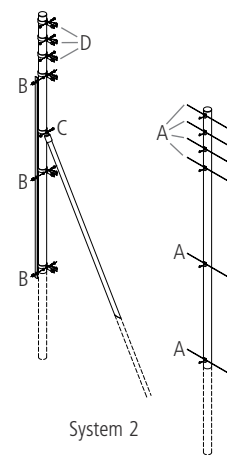

System 2

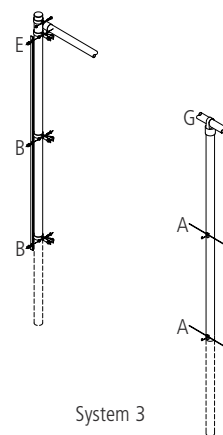

System 3

Systems 4, 5 and 6 continue on next page

Key GALV = Hot Dipped Galvanised PPC = Polyester Powder Coated

All Prices Exclude VAT

Buy Online: www.jacksons-fencing.co.uk or Call: 0800 41 43 43 for Sales or Advice

Galvanised Tubular Fencing System continued

System 4

Fence Height	Intermediate posts			End posts			Corner - 2 way posts		
	Ref	GALV	PPC	Ref	GALV	PPC	Ref	GALV	PPC
1.8m	061318BM	£29.00	£34.70	062318BM	£57.00	£69.45	063318BM	£82.25	£101.55
2.0m	061320BM	£31.45	£37.55	062320BM	£59.55	£72.60	063320BM	£85.40	£105.45
2.4m	061324BM	£38.70	£45.55	062324BM	£67.05	£81.80	063324BM	£96.45	£119.25
2.75m	061327BM	£44.90	£52.35	062327BM	£116.80	£151.10	063327BM	£192.50	£253.90
3.05m	061330BM	£62.95	£70.85	062330BM	£137.65	£182.25	063330BM	£214.10	£287.65
3.6m	061336BM	£71.30	£88.70	062336BM	£147.75	£194.60	063336BM	£225.95	£301.30

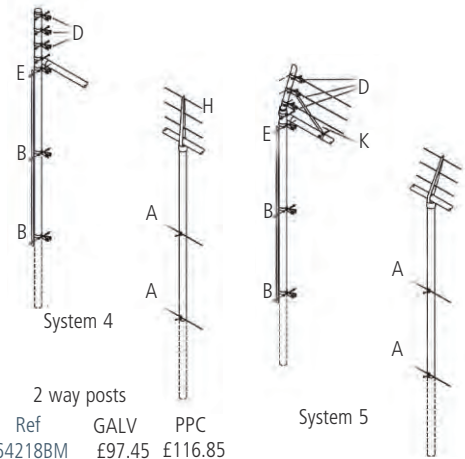

System 4

System 5

System 5

Fence Height	Intermediate posts			End posts			Corner posts			2 way posts		
	Ref	GALV	PPC	Ref	GALV	PPC	Ref	GALV	PPC	Ref	GALV	PPC
1.8m	061218BM	£29.00	£34.70	062218BM	£69.30	£81.85	063218BM	£98.75	£118.15	064218BM	£97.45	£116.85
2.0m	061220BM	£31.45	£37.55	062220BM	£71.85	£85.00	063220BM	£101.90	£122.05	064220BM	£101.60	£121.75
2.4m	061224BM	£38.70	£45.55	062224BM	£79.35	£94.30	063224BM	£114.50	£138.10	064224BM	£114.20	£137.80
2.75m	061227BM	£44.90	£52.35	062227BM	£146.70	£181.20	063227BM	£226.60	£289.30	064227BM	£226.75	£289.45
3.05m	061230BM	£62.95	£70.85	062230BM	£150.90	£187.80	063230BM	£231.55	£298.55	064230BM	£231.70	£298.70
3.6m	061236BM	£71.30	£88.70	062236BM	£161.00	£207.55	063236BM	£243.45	£320.35	064236BM	£243.55	£320.45

System 6

Fence Height	Intermediate posts			End posts			Corner posts			2 way posts		
	Ref	GALV	PPC	Ref	GALV	PPC	Ref	GALV	PPC	Ref	GALV	PPC
1.8m	061418BM	£39.05	£45.15	062418BM	£78.45	£91.95	063418BM	£108.45	£129.35	064418BM	£106.20	£127.10
2.0m	061420BM	£41.50	£48.00	062420BM	£81.00	£95.10	063420BM	£111.60	£133.30	064420BM	£110.30	£132.00
2.4m	061424BM	£48.75	£56.00	062424BM	£88.50	£104.40	063424BM	£122.65	£147.20	064424BM	£121.40	£145.95
2.75m	061427BM	£54.95	£62.75	062427BM	£138.25	£173.70	063427BM	£218.70	£281.80	064427BM	£217.40	£246.85
3.05m	061430BM	£73.00	£81.30	062430BM	£157.05	£194.90	063430BM	£238.20	£305.60	064430BM	£237.35	£271.10
3.6m	061436BM	£81.35	£99.15	062436BM	£167.15	£214.65	063436BM	£250.10	£327.35	064436BM	£249.25	£292.90

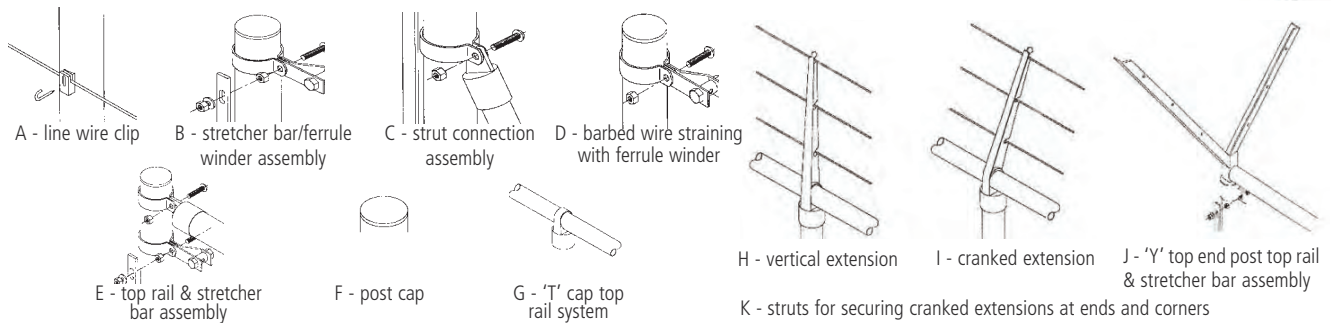

System 6

Top Rail

	Ref	Galv	Ref	PPC
6m with connector	064000BM	£36.50	964000BM	£62.60

All prices were correct at the time of printing, but due to fluctuating raw material costs we reserve the right to alter prices. The latest product prices can be found on our website.

Key GALV = Hot Dipped Galvanised PPC = Polyester Powder Coated

● STOCK ITEMS ○ MADE TO ORDER (CANNOT BE CANCELLED ONCE ORDERED) ■ CHECK FOR AVAILABILITY ▼ WHILE STOCK LASTS ✱ INCLUDES BOLTS AND SCREWS

Tubular Gate System (page 145)

Chain Link Gates

Gate Height	Plastic Coated Infil		Galvanised Infill	
	Ref	Price	Ref	Price
0.86m	309610	£206.95	309661	£206.95
1.17m	309710	£213.60	309771	£213.60
1.32m	309810	£224.30	309881	£224.30
1.78m	309910	£252.00	309991	£252.00
2m high tennis court gate made in a frame for easy installation fitted with an integral key lock				
			051020BM	£388.00

Tubular Tennis Court Surrounds

Items	Single Court Price	Double Court Price
Post	£1329.60	£1828.20
Top Rail	£657.00	£876.00
Tennis Court Gates	£388.00	£776.00
Chain Link	£1215.00	£1620.00
Tying wire	£13.90	£13.90
Corner Posts	£698.00	£698.00
Total	£4301.50	Total £5812.10

Chain Link Galvanised - 50mm Mesh Inc Line Wire (page 146)

Roll Height	0.9m		1.2m		1.4m		1.8m		2.0m		2.4m		2.75m		3.05m			
Standard No. of Line Wires	2		3		3		3		3		4		5		5			
Wire Size	Gauge	Length	Ref	Price	Ref	Price	Ref	Price	Ref	Price	Ref	Price	Ref	Price	Ref	Price		
2.5mm	12½g	25m 12.5m	300100 ●	£78.90	300200 ●	£106.45	300300 ●	£123.65	300400 ●	£154.00	311700 ●	£83.30	307000 □	£115.20	305000 □	£136.40		
3.0mm	10½g	25m 12.5m	300500 ●	£116.30	300600 ●	£153.00	300700 ●	£177.00	300800 ●	£111.50	315300 □	£139.90	303700 ●	£151.00	305200 □	£194.00	303800 □	£214.00
3.55mm	9½g	12.5m	305900 □	£89.75	306100 □	£132.65	306900 □	£141.00	315700 □	£187.00	316100 □	£196.00	316500 □	£235.00	316900 □	£264.00	317300 □	£292.00

Chain Link Galvanised PVC Coated - 50mm Mesh Inc Line Wire (page 146)

Roll Height	0.9m		1.2m		1.4m		1.8m		2.0m		2.4m		2.75m		3.05m		
Standard No. of Line Wires	2		3		3		3		3		4		5		5		
Wire Size	Length	Ref	Price	Ref	Price	Ref	Price	Ref	Price	Ref	Price	Ref	Price	Ref	Price	Ref	Price
1.7/2.5mm (Green only)	25m 10m	300900 ●	£45.50	301000 ●	£60.65	301100 ●	£69.90	301200 ●	£88.30	303300 ●	£21.60	303400 ●	£27.10	303500 ●	£31.90	303600 ●	£40.75
2.24/3.15mm 13½/10½g.	25m 12.5m	301300 ●	£72.75	301400 ●	£95.50	301500 ●	£110.85	301600 ●	£140.00	305500 ●	£97.90	307500 ●	£117.00	305400 ●	£135.00	305700 □	£171.00
2.5/3.55mm 12/9½g.	12.5m	302912 ●	£49.60	303012 ●	£65.40	303112 □	£75.85	303212 ●	£98.25	304500 □	£140.60	306300 □	£173.00	305600 ●	£189.00	306500 □	£206.00
3.0/4.0mm 10½/8g.	12.5m	309500 □	£96.75	310000 □	£128.00	312100 □	£158.00	304000 ●	£154.00	306700 □	£199.00	304100 ●	£245.00	307100 □	£269.00	304200 □	£297.00
3.55/4.75mm 9½/6½g.	12.5m	321900 □	£131.00	322000 □	£176.00	322100 □	£202.00	307900 □	£252.00	308000 □	£279.00	308100 □	£342.00	308200 □	£379.00	308300 □	£419.00

All prices were correct at the time of printing, but due to fluctuating raw material costs we reserve the right to alter prices. The latest product prices can be found on our website.

All Prices Exclude VAT

Buy Online: www.jacksons-fencing.co.uk or Call: 0800 41 43 43 for Sales or Advice

Welded Mesh Heavy and Light (page 147)



Welded Mesh (Light)

6m Roll

Height	Mesh (mm)	Gauge	Ref	Price
900mm	13 x 13	19	364000 ●	£15.20
900mm	13 x 25	19	364100 ●	£11.60
900mm	25 x 25	16	364400 ●	£21.80

30m Roll

Height	Mesh (mm)	Gauge	Ref	Price
900mm	13 x 13	19	362100 ●	£70.85
900mm	13 x 25	19	362700 ●	£55.00
900mm	25 x 25	16	362400 ●	£95.00

Chain Link Accessories (page 149)

Stretcher bar kits (1)

Height	No. of Angle Cleats, Eyebolts, Adaptors & Hex bolts per bar	Ref	Price
0.9m	2	301700BM ●	£11.50
1.2m	3	301800BM ●	£16.70
1.4m	3	301900BM ●	£17.20
1.8m	3	302000BM ●	£18.95

Stretcher bars hot dip galvanised (2)

Size	Ref	Price
900 x 5mm 2 holes	335030 ●	£3.85
1050 x 5mm 2 holes	335730 ●	£4.20
1200 x 5mm 3 holes	335130 ●	£5.10
1400 x 5mm 3 holes	335230 ●	£5.60
1500 x 5mm 3 holes	335830 ●	£5.95
1800 x 5mm 3 holes	335330 ●	£8.70
2000 x 5mm 3 holes	335930 ●	£8.40
2100 x 5mm 3 holes	335430 ■	£8.75
2400 x 5mm 4 holes	335530 ●	£10.70
2750 x 5mm 5 holes	335630 ●	£12.30
3000 x 5mm 5 holes	334830 ●	£13.50

Welded Mesh (Heavy)

Height	Mesh (mm)	Wire Size	Length of Roll	Finish	Ref	Price
0.9m	50 x 50	2.5mm	25m	Galv.	520000 ●	£105.60
0.9m	50 x 50	3.0mm	25m	Galv.	520100 ●	£131.50
0.9m	50 x 50	3.1/2.5mm	25m	Green PVC	520300 ●	£141.00
1.2m	50 x 50	2.5mm	25m	Galv.	520400 ●	£141.00
1.2m	50 x 50	3.0mm	25m	Galv.	520500 ●	£193.00
1.2m	50 x 50	3.1/2.5mm	25m	Green PVC	520800 ●	£179.00
1.8m	50 x 50	2.5mm	25m	Galv.	521500 ●	£169.00
1.8m	50 x 50	2.5mm	25m	Galv.	521600 ●	£230.00
1.8m	75 x 25	3.0mm	25m	Galv.	521700 □	£327.00
1.8m	50 x 50	3.0mm	25m	Green PVC	521900 □	£238.00
2.4m	50 x 50	3.1/2.5mm	12.5m	Galv.	522100 ●	£135.30
2.4m	50 x 50	2.5mm	12.5m	Galv.	522200 ●	£192.90
2.4m	75 x 25	3.0mm	12.5m	Galv.	522999 □	£262.00
2.4m	75 x 25	3.0mm	12.5m	Galv.	522300 □	£241.00
0.9m	50 x 50	3/3.5mm	25m	Green PVC	522750 □	£172.00
1.2m	50 x 50	3/3.5mm	25m	Green PVC	522760 □	£223.00
1.8m	50 x 50	3/3.5mm	25m	Green PVC	522780 □	£331.00
2.4m	50 x 50	3/3.5mm	25m	Green PVC	522800 □	£444.00
0.9m	50 x 50	3/3.5mm	25m	Black PVC	522759 □	£172.00
1.2m	50 x 50	3/3.5mm	25m	Black PVC	522769 □	£223.00
1.8m	50 x 50	3/3.5mm	25m	Black PVC	522789 □	£460.00
2.4m	50 x 50	3/3.5mm	25m	Black PVC	522809 □	£444.00

Bolts for stretcher bars with 2 nuts galvanised (3)

Size	Ref	Price
M8 x 40 (supplied in 100s)	336000 ●	£18.95

Galvanised Angle Cleats (4)

Size	Ref	Price
40 x 40 x 5mm	336100 ●	£0.55
50 x 50 x 6mm	336200 ●	£1.05

Galvanised Eye Bolts (5)

Size	Ref	Price
200 x 10 mm	344000 ●	£1.50
300 x 10mm	341800 ●	£1.75
300 x 12mm	341700 ●	£3.30

Galvanised Loop Adaptors for 10mm Eye Bolts (6)

Ref 341880 ●	Price £1.30
--------------	-------------

Strainers Galvanised (7,8,9)

Type	Ref	Price
G Ratchet - Heavy duty	342000 □	£4.05
H Radisseur - Large	341900 □	£2.75
I Ferrule	342400 ●	£0.90

Barbed Wire Stays (10)

710mm x 30mm x 6mm. Galvanised & notched for 3 rows of barbed wire	Ref 342300 ●	Price £5.15
--	--------------	-------------

Tying Wire 1kg Coils

Type	Ref	Price
16g.(1.6mm) Galvanised 62m	338000 ●	£6.95
14g.(2.0mm) Green PVC coated 70m	338100 ●	£7.95

Line Wire PVC coated green

	25kg	Price	26m	Price
2.24/3.15mm 710m	339400 ●	£88.00	337400 ●	£9.35
2.50/3.55mm 550m	339500 ●	£88.00	337500 ●	£9.35
3.00/4.00mm 420m	339600 ●	£88.00	337600 ●	£11.25
3.55/4.75mm 280m	339700 ●	£88.00	337700 □	£23.40



Fixing Tools and Miscellaneous (page 152)

Jakclips (1)

Ref 645000 ● Price £4.25

Ballast 20kg bag

Ref 648110 ● Price £2.30

Postcrete 20kg bag

Ref 648070 ● Price £4.95

Mastercrete (3) 25kg bag

Ref 648220 ● Price £11.15

Standard cement 25kg bag

Ref 648200 ● Price £4.95

Countersunk Supascrews (5)

Length	Size	Per 200	Price	Per 10	Price
40mm	4mm	809000 ●	£4.99	809010 ●	£0.29
45mm	5mm	809100 ●	£9.45	809110 ●	£0.50
50mm	5mm	809200 ●	£10.50	809210 ●	£0.60
65mm	5mm	809300 ●	£11.70	809310 ●	£0.65
75mm	5mm	809400 ●	£16.20	809410 ●	£0.95

Bolts & Nuts Cup Square Galvanised (4)

Length mm	M8 Ref	Price	M10 Ref	Price	M12 Ref	Price
50	803900	£0.28	805600	£0.47	807300	£0.71
55	804000	£0.32	805700	£0.51		
65	804100 ●	£0.35	805800 ●	£0.54	807500	£0.83
75	804300 ●	£0.37	806000 ●	£0.59	807600 ●	£0.90
90	804500 ●	£0.45	806200 ●	£0.70		
100	804600 ●	£0.56	806300 ●	£0.79	807800 ●	£1.10
110	804700 ●	£0.61	806400 ●	£0.84	807900 ●	£1.18
130	804800 ●	£0.68	806500 ●	£1.00	808000	£1.36
140			806600 ●	£1.06		
150	804900 ●	£0.77	806700 ●	£1.13	808100	£1.52
160			806800 ●	£1.61	808200	£2.88
180	805000 ●	£1.17	806900 ●	£1.83	808300	£2.98
220			807100 ●	£2.12	808500	£3.60

Jakcured Timber Spur Posts (2)

Ref 756310 ■ Price £15.25

Coach Screws Square (6)
Chamfered head Gimlet Point

Length	M8 Ref	Price	M10 Ref	Price
65mm	810500	£0.64		
75mm	810600 ●	£0.66		
90mm			811100	£1.21
100mm			811200 ●	£1.28

Roofing bolts - Galvanised (7)

Diam.	Length	Ref per 100	Price
M8	40mm	813000 ●	£13.90

Heavy Iron Washers - Metric Galvanised (8)

Bolt Size	O.D.mm	Approx. Thickness	Per 100		Per 10	
			Ref	Price	Ref	Price
M8	21	2.0mm	811800 ●	£6.50	812300 ●	£0.85
M10	24	2.0mm	811900 ●	£7.65	812400 ●	£1.10
M12	28	2.5mm	812000 ●	£8.80	812500 ●	£1.65

Stainless Steel Nails

50mm	1kg Bag		5kg Box	
	Ref	Price	Ref	Price
	800710 ●	£13.70	800750 ●	£49.85



Jakcure® End Grain Treatment

Where cutting or drilling after treatment cannot be avoided use Jakcure® End Grain Treatment to ensure no timber is left untreated. 500g bottle

Ref	Price
131212 ●	£5.50

All prices were correct at the time of printing, but due to fluctuating raw material costs we reserve the right to alter prices. The latest product prices can be found on our website.

Fixing Tools and Miscellaneous (page 151)

Galvanised Staples (1)

Size mm	Approx Count per kg	Ref	Price	Ref	Price	Ref	Price
		20 kg Carton		5 kg Tub		1 kg Tub	
20 x 2.00	1079	801020 ●	£62.90	801050 ●	£19.25	801010 ●	£4.25
30 x 3.55	226	801120 ●	£62.90	801150 ●	£19.25	801110 ●	£4.25
40 x 4.00	136	801220 ●	£62.90	801250 ●	£19.25	801210 ●	£4.25



Galvanised (Barbed) Staples (2)

Size	Approx Count per kg	Ref	Price	Ref	Price	Ref	Price
		20kg Carton		5kg Tub		1kg Tub	
30mm x 3.15	250	328620 ●	£59.80	328650 ●	£17.20	328610 ●	£5.65

Fixing Tools and Misc (continued)

Wire Nails (Galvanised Wire) (3)

Length	Approx Count per kg	Ref	Price	Ref	Price	Ref	Price
		25kg Carton		5kg Tub		1kg Tub	
50mm	441	800100 ●	£59.50	800150 ●	£14.70	800110 ●	£4.70
65mm	216	800400 ●	£59.50	800450 ●	£14.70	800410 ●	£4.70
75mm	145	800200 ●	£59.50	800250 ●	£14.70	800210 ●	£4.70
100mm	79	800300 ●	£59.50	800350 ●	£14.70	800310 ●	£4.70
125mm	42	800500 ●	£59.50	800550 ●	£14.70	800510 ●	£4.70
150mm	31	800600 ●	£59.50	800650 ●	£14.70	800610 ●	£4.70

Brenton's Pattern Galvanised Bolts (10)

Size	No. of Screws/ Bolts	Ref	Price
150mm	4/4	344900 ●✳	£3.75
200mm	4/4	345000 ●✳	£4.30
250mm	4/4	345100 ●✳	£5.95
300mm	4/4	345200 ●✳	£7.95

Resin Anchor (4)

Ref 070007 ● Price £9.95

Steel Locking Bars (7)

Size	Ref	Price
300mm	354000 ●	£15.95

Gate Return Spring (11)

250mm Epoxy Black	Ref	Price
	346800 ●	£7.95

Padlocks (13 & 14)

Size	Ref	Price
A Padlock 60mm	357100 ●	£12.65
Also available RADAR padlock with 3 keys see page 114	284550BM	£60.80

Resin Applicator (5)

Ref 070009 ● Price £27.50

Arris Rail Repair Brackets (8)

Size	Ref	Price
300mm	420300 ●	£1.65

Lift Gate Hook (12)

With coach screws to take 38mm rails	Ref	Price
	420400 ●✳	£3.85

Studding (6)

Type	Ref	Price
M8	070008	£2.50
M10	070010 ●	£2.95
M12	070012	£4.25
M16	070016	£6.10

Heavy Cross Bolt (9)

Size	Ref	Price
450mm	352400 ●✳	£17.95

Monkey Tail Bolts (15)

Size	Ref	Price
450 x 16mm	353400 ●	£21.95

Tea Hinges (16)

Length of tail	300mm	400mm	450mm	600mm
Ref	344500 ●✳	344600 ●✳	344700 ●✳	344800 ●✳
Price per pair	£4.70	£5.20	£5.65	£12.85

Fixing Tools and Miscellaneous (page 152)

Ring Latches Galvanised (1)

Both with two ring handles

Item	Ref	Price
Heavy 125mm	350300 ● *	£7.75
Extra Heavy 175mm	355000 ● *	£12.25

Jackson Heavy Duty Hand Ring Clip Gun (7)

Ref 523200 ● Price £143.50

Heavy Reversible Hinges (11)

Size mm	per pair	Price
620 x 19	352900 ● *	£25.30
780 x 19	353300 ● *	£36.40
930 x 19	353000 ● *	£46.20

Hook & Band Hinge (12)

Price per pair	Ref	Price
Cranked folded eye 400mm	350200 ● *	£12.55

Automatic Latch (2)

Ref 350400 ● * Price £3.25

Pad Bolt (3)

Size	Ref	Price
100mm	351300 ● *	£3.70

Non rust aluminum clips (8) Box of 2,500

Ref 523300 ● Price £152.00

Adjustable Hook & Band Hinge (13)

Size	Per Pair	Price
400mm	350550 ● *	£13.60

Size	Per Pair	Price
400mm	350500 ● *	£18.15
500mm	350800 ● *	£22.75
700mm	351770 ● *	£26.20

Cabin Hook (4)

Size	Ref	Price
100mm	351550 ● *	£2.10
150mm	351660 ● *	£2.30

Ring Gun (5)

Ref 410400 ● Price £65.60

Welded Mesh Clip Tool (9)

Ref 523100 ● Price £340.00

Ring Fasteners (6)

In packs of 1000

Item	Ref	Price
Galvanised	410500 ●	£10.65
Stainless Steel	410550 ●	£30.85

Welded Mesh Clips (10) In box of 1443

Ref 523000 ● Price £88.65

Fencing Pliers (14)

Ref 370700 ● Price £16.90

Wire Cutters (15)

Items as described on page 155

	Ref	Price
A	334000 ●	£79.00
B	334100 ●	£25.50
C	334200 ●	£68.30



(14)

Fixing Tools and Misc

Claw Hammer (1)

Ref 371200 ● Price £8.50

Post Level (5)

Ref 400800 ● Price £13.40

Wire Tying Tool (2)

Ref 349700 ● Price £36.50

'Monkey' Hole Borer (6)

Size	Ref	Price
150mm diameter	392000 ●	£106.50
225mm diameter	392100 ●	£139.00

Wire Tensioning Tool (3)

Ref 346900 ● Price £46.50

Post Driver (7)

Item	Ref	Price
No. 5 for posts up to 120mm diam.	400600 ●	£84.95
No. 6a for posts up to 146mm diam. (two handles)	400700 ●	£99.90

Wire Ties Galvanised (4)

Price per 1000

2mm wire	Ref	Price
100mm Galvanised	348900 ●	£18.55
200mm Galvanised	563492 ●	£36.90

Hickory Mattock & Pickaxe Handle (10)

900mm

Ref 347800 ● Price £19.45

Sledge Hammer (11)

10lb.

Ref 347200 ● Price £33.95

Square Rammer (12)

10lb. Head

Ref 346200 ● Price £29.90

Grafting Spade (13)

Ref 401500 ● Price £55.50

Spade Rabbeting - Telecom (14)

Size 124mm x 320mm

Ref 346700 ● Price £70.65

Heavy Duty Shovholer Hole Digger (15)

Ref 401400 ● Price £92.50

Crowbar Chisel & Point (16)

1.5m

Ref 346300 ● Price £36.95

Post Maul (17)

Ref 345330 ● Price £31.50

All prices were correct at the time of printing, but due to fluctuating raw material costs we reserve the right to alter prices. The latest product prices can be found on our website.

All Prices Exclude VAT

Buy Online: www.jacksons-fencing.co.uk or Call: 0800 41 43 43 for Sales or Advice

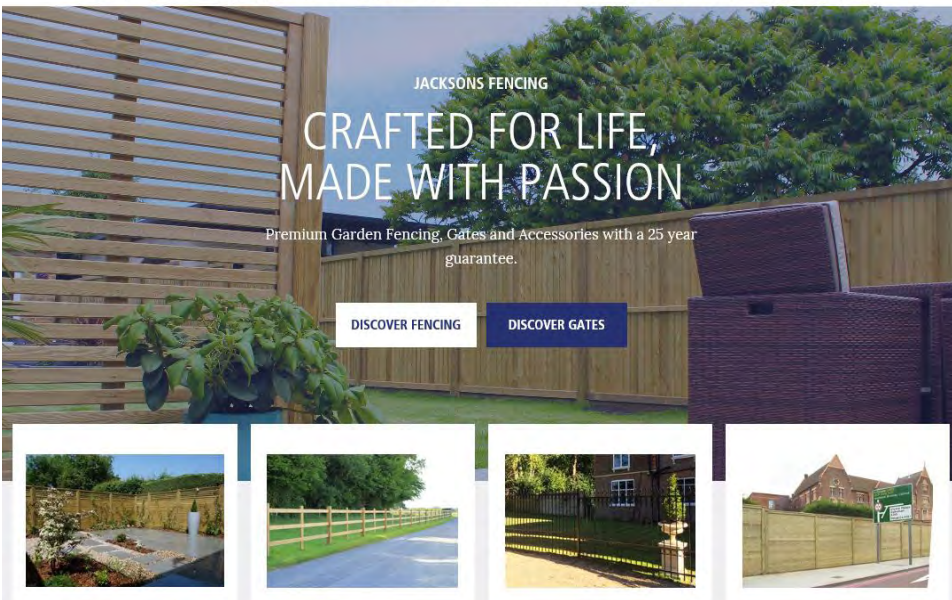

You can access information, order online, or try our Fence Builder to help you work out what you need for your next project.

At Jacksons we are always happy to hear from our customers, in fact we take pride in being able to assist you with any query you have regarding your fencing or garden project, or any other part of our service.

We have gathered up many of the most frequently asked questions (FAQs) on our website for you to access at any time.

0800 408 2234

Jacksons Fencing

Hello Sign in MY ACCOUNT



CONTACT US

Home / Fence Calculator & Builder

FENCE CALCULATOR



STEP 1: SELECT YOUR PANEL STYLE



Featherboard from £20.95

Viewing style 1 of 25

Set Fence Height

0.75m (£20.95)



If you want to try the Fence Builder, look at the top of the home page and it's within the main menu under calculators and specifiers.

Obviously we're still here to answer any of these queries too, during our normal business hours.

Metric / Imperial Conversion Chart*

mm	inch	m	ft & inches
25	1	0.9	2' 11 1/2"
32	1 1/4	1.05	3' 5 1/2"
38	1 1/2	1.2	3' 11"
50	2	1.5	4' 11"
60	2 3/8	1.8	5' 10 1/2"
75	3	1.83	6'
100	4	2.1	6' 10"
125	5	2.4	7' 10"
150	6	2.7	8' 10"
175	7	3	9' 10"
200	8	3.3	10' 9 1/2"
250	10	3.6	11' 9 1/2"
300	12	3.9	12' 9 1/2"
400	16	4.2	13' 9"
500	20	4.6	15' 1"
600	24		

Roll Lengths

4.55m	15 ft/5 yds
6m	20 ft
9.1m	30 ft/10 yds
10m	32 ft
12.5m	41 ft
25m	82 ft
30m	98 ft

Wire Gauges - Galv

● 1.6mm	16g
● 2.0mm	14g
● 2.5mm	12 1/2g
● 3.0mm	10 1/2g
● 3.15mm	10g
● 3.5mm	9 1/2g
● 4.0mm	8g
● 5.0mm	6g

Wire Gauges - PVC coated

2.24/3.15mm	13 1/2/10 1/2g
2.5/3.55mm	12 1/2/9 1/2g
3.0/4.0mm	10 1/2/8g
3.55/4.75mm	9 1/2/6 1/2g

*The conversions from Metric to Imperial measurements shown here are nominal.

If you have any difficulty in working out any dimensions in our brochure or price booklet:
Please do call 0800 41 43 43.

More Reasons to Choose Jacksons Fencing

Jacksons has achieved certification under the environmental chain-of-custody schemes of both the FSC[®] (Forest Stewardship Council[®]) and the PEFC[™] (Programme for the Endorsement of Forest Certification[™]).

The majority of our timber product range can be offered certified under one of these two schemes. The environmental chain-of-custody which is monitored from forest source, to primary producer sawmills, through to Jacksons, allows us to ensure that all timber used in certified Jacksons products has been sourced from well managed forests and other controlled sources. However, despite the enormous added environmental and social value that this brings, there is no increased price to the customer. (Ask for FSC[®] or PEFC[™] certified products).



The mark of
responsible forestry



Delivery Charge (per each drop)

Mainland - England and Wales south of (and not including) the counties of Cumbria, Durham and Cleveland.

	National	London
For orders under £50.00 add	£21.50 + VAT	£31.50 + VAT
For orders under £150.00 add	£30.00 + VAT	£40.00 + VAT
For orders over £150.00 add	£42.00 + VAT	£52.00 + VAT

Local deliveries from our fencing centres are charged at half of the above prices. For order values over £2000 delivery is FREE.

Express delivery - 24 and 48 hours can be arranged at additional cost.

We shall be pleased to quote competitively for delivery to north of Lancashire/Yorkshire border, Scotland, Ireland, I.O.M., The Orkneys and The Shetlands.

For the Channel Islands Please Contact our Distributors:

Guernsey Distributor: R H Gaudion & Sons Ltd Tel: 01481 257 361

Jersey Distributor: J F (T) U Town & Country Tel: 01534 733277

Isle of Wight Distributor: County Fencing - 01983 741207

Please note our drivers are instructed not to take their lorries off the hard road.

Jacksons Fencing: Approved Installer Programme

Jacksons offers you a nationwide service that you can absolutely rely on. Our Approved Installers have all been carefully selected and are highly experienced professionals who will do the job competitively and without skimping - and get it right!



We have developed a Customer Charter for your reassurance of our joint commitment to quality. This Charter establishes the Code of Practice expected from a Jacksons Approved Installer and your expectations from them.

A copy of your Charter will be presented to you with your quotation.

Throughout the process from enquiry to completion of the installation, specific quality procedures must be adhered to by both Jacksons and the Jacksons Expert Installer. These cover all aspects of the installation in accordance with Jacksons instructions and best practices, working competently and responsibly throughout the duration of the contract.

Please call - 0800 41 43 43 with your initial enquiry and we will arrange for a Jacksons Approved Installer to contact you and give you a no obligation quotation.



Jacksons Fencing

Crafted For Life, Made With Passion.



Discover Premium Quality Fencing,
Gates and Accessories
With a 25 Year Guarantee.

www.jacksons-fencing.co.uk

Issue 2 - Volume 2
JF/MKT/PG/0319/V2

Jacksons Fencing: Head Office, Stowting Common, Ashford, Kent, TN25 6BN | 01233 750393

Fax: 01233 750403 | International: +44 (0) 1233 750393

Locations: Ashford, Bath and Chester

Email: sales@jacksons-fencing.co.uk | www.jacksons-fencing.co.uk

Registered Office: Stowting Common, Ashford, Kent, TN25 6BN, United Kingdom. Registered in England No. 910291